

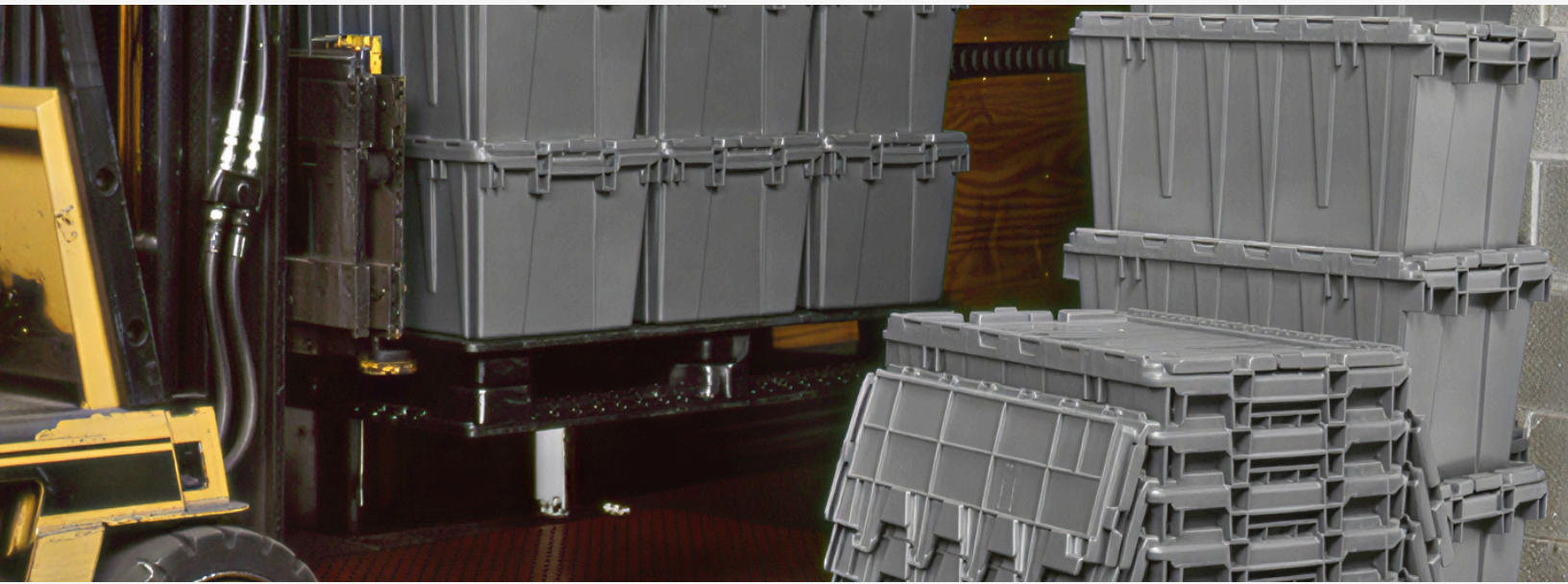

Caster-Rack
Systems Ltd.

AK-WEST INC.
Leaders in Reusable Containers and Material Handling Solutions

MATERIAL HANDLING STORAGE SOLUTIONS

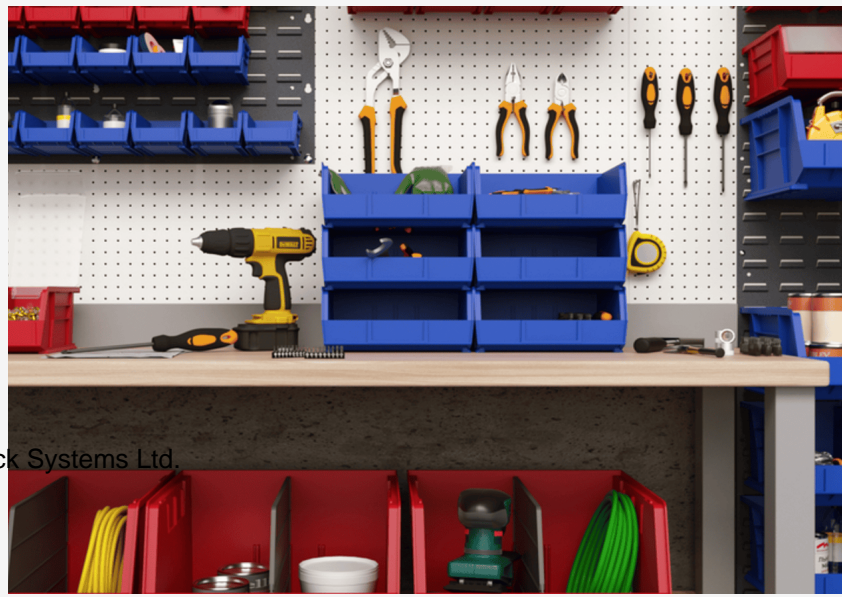
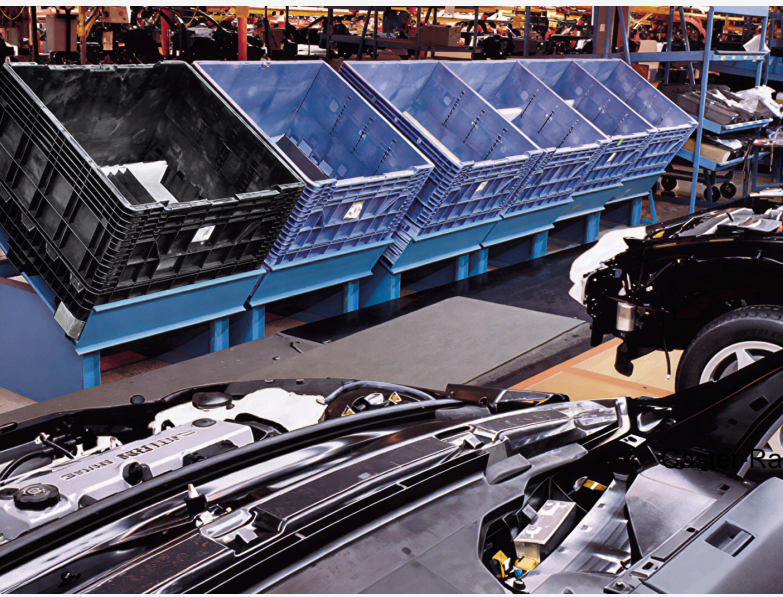

ORGANIZE SUPPLIES • REDUCE INVENTORY • PRODUCT PROTECTION

www.ak-westinc.com

5S LEAN AND KANBAN SOLUTIONS

SORT • SET IN ORDER • SHINE • STANDARDIZE • SUSTAIN

Boost Efficiency & Organization with 5S Lean Solutions

Transform your workspace with Ak-West Inc.'s industry-leading material handling products—designed to support the proven 5S Lean methodology. Whether you're streamlining operations, reducing waste, or improving safety, our solutions help you:

- Optimize inventory levels and reduce carrying costs.
- Maximize usable workspace.
- Enhance safety and minimize downtime.
- Improve visual control and accountability.
- Empower teams and elevate morale.
- Accelerate problem detection and resolution.



SORT: Eliminate Clutter, Elevate Clarity

Start your 5S journey by removing unnecessary tools and materials. Ak-West Inc. offers smart bin solutions to simplify sorting and categorization:

- Storage bins with large hopper fronts for quick access and efficient picking.
- Available in multiple sizes and colours for visual organization.
- Clear bins for instant identification of contents.
- Ideal for both compact and large-scale workspaces.



SET IN ORDER: Organize for Speed and Simplicity

Arrange tools and materials so everything is easy to find and within reach. Our modular systems make it simple to create intuitive, efficient layouts:

- Labelled bins and shelf spaces ensure items are always returned correctly.
- Louvered panels for vertical storage and space optimization.
- Wire and steel shelving systems for custom configurations.
- Mobile carts and racks for flexible, on-the-go organization.
- Hanging and stacking bins to group related items together.

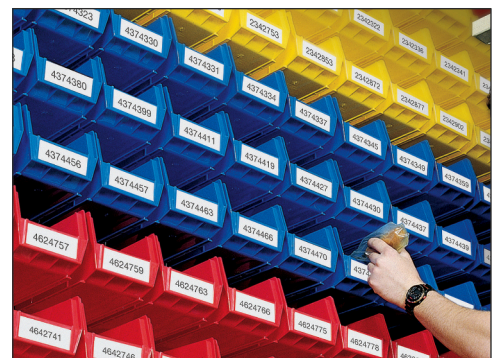

5S LEAN AND KANBAN SOLUTIONS

SORT • SET IN ORDER • SHINE • STANDARDIZE • SUSTAIN

SHINE: Clean, Protect, and Maintain

Keep your workspace clean and your equipment protected. Ak-West products help you implement a proactive cleaning and maintenance routine:

- Lidded containers to shield contents from dust and debris.
- Grid containers with dividers and optional lids for compartmentalized storage.
- Drawer bins with enclosed shelving for secure, dust-free organization.
- Nestable containers with attached or detached lids for easy cleaning and compact storage.



STANDARDIZE: Create Consistency, Drive Performance

Establish repeatable processes and visual standards to eliminate waste and boost productivity:

- Kanban systems to maintain optimal inventory levels.
- Two-tone indicator bins for instant supply status recognition.
- Super-sized stackable bins for secure, space-saving storage.
- Portable workstations to integrate 5S into daily routines.
- Colour-coded bins, carts, and hoppers for universal process alignment.



SUSTAIN: Build a Culture of Continuous Improvement

Empower your team to maintain and improve the workspace with durable, high-performance solutions:

- Reinforce best practices with consistent evaluation and feedback.
- Plastic and steel material handling products built for long-term efficiency.
- Support lean workflows with reliable storage, transport, and organization systems.



TABLE OF CONTENTS

MATERIAL HANDLING STORAGE SOLUTIONS

Hanging and Stacking Bins	3	Caliber IBC Containers	43
ESD Bins	5	Fixed Wall Bulk Containers	44
Insight Bins	6	Forklift Bins	45
4" Shelf Bins	7	Tote Caddy	46
6" Shelf Bins	9	ProBox Toolboxes	46
Indicator Bins	11	Storage Cases	47
High Visibility Stack and Shelf Bins	12	Utility Boxes	47
1800 Series Bins	12	Plastic Bin Cabinets	48
Stack-Nest Shelf Bins	13	Steel Bin Cabinets	49
System Bins	13	Storage-Go-Round	50
Drawer Bins	14	Heavy-Duty Cabinets	51
Stacking Bins	15	Louvered Panels	52
Stack-N-Store Bins	17	Rail Systems	54
TiltView Bins	18	<small>Caster-Rack Systems Ltd.</small> Pick Racks	56
Rackable Bins	19	Wire Shelving	58
Stack and Nest Containers	20	Wire Shelving Components	61
Cross Stack and Nest Containers	25	Wire Shelving Accessories	62
Stack and Nest Trays	26	Label Holders	63
Collapsible Crates	26	Platform Deck Trucks	64
Multi-Purpose Trays	27	Dollies	65
Detached Lid Containers	28	Industrial Step Stands	65
Harvesting Baskets	29	ProCart Utility Carts	66
General Purpose Nesting Containers	29	Utility Box Carts	67
Attached Lid Containers	30	Next Generation Utility Carts	69
Straight Wall Containers	33	Bulk Handling Linen Carts	70
Grid Containers	36	Jumbo Utility Carts	71
Plastic Pallets	37	Tilt Trucks	72
Bulk Containers	38	Recycling and Waste Containers	74
Centerflow Containers	41	SOS Storage Bins	75
Intrepid IBC Containers	42		

TABLE OF CONTENTS

MATERIAL HANDLING STORAGE SOLUTIONS

						
Hanging and Stacking Bins 3	ESD Bins 5	Insight Bins 6	4" Shelf Bins 7	6" Shelf Bins 9	Indicator Bins 11	High Visibility Bins 12
						
1800 Series Bins 12	Stack-Nest Shelf Bins 13	System Bins 13	Drawer Bins 14	Stacking Bins 15	Stack-N-Store Bins 17	TiltView Bins 18
						
Rackable Bins 19	Stack and Nest Containers 20	Cross Stack and Nest Cont. 25	Stack and Nest Trays 26	Collapsible Crates 26	Multi-Purpose Trays 27	Detached Lid Containers 28
						
Harvesting Baskets 29	General Purpose Containers 29	Attached Lid Containers 30	Straight Wall Containers 33	Grid Containers 36	Plastic Pallets 37	Bulk Containers 38
						
CenterFlow Containers 41	Intrepid IBC Containers 42	Caliber IBC Containers 43	Fixed Wall Bulk Containers 44	Forklift Bins 45	Tote Caddy 46	ProBox Toolboxes 46
						
Storage Cases 47	Utility Boxes 47	Plastic Bin Cabinets 48	Steel Bin Cabinets 49	Storage-Go-Round 50	Heavy-Duty Cabinets 51	Louvered Panels 52
						
Rail Systems 54	Pick Racks 56	Wire Shelving 58	Wire Shelf Components 61	Wire Shelf Accessories 62	Label Holders 63	Platform Deck Trucks 64
						
Dollies 65	Industrial Step Stands 65	ProCart Utility Carts 66	Utility Box Carts 67	Next Generation Utility Carts 69	Bulk Handling Linen Carts 70	Jumbo Utility Carts 71
						
Tilt Trucks 72	Recycling and Waste Cont. 74	SOS Storage Bins 75				

Caster-Rack Systems Ltd.

HANGING AND STACKING BINS

EFFICIENTLY HANG, STACK, AND ORGANIZE



Hanging and Stacking Bins – Sturdy, and Space-Saving!

Maximize your storage efficiency with our heavy-duty Hanging & Stacking Bins! Designed for ultimate functionality, these bins keep inventories organized, speed up assembly processes, and minimize parts handling—helping you work smarter, not harder.

FEATURES:

- 1 **Stable & Secure:** Anti-slide stop prevents shifting when stacked.
- 2 **Customizable Storage:** Optional dividers create adaptable compartments.
- 3 **Versatile Hanging:** Full-width hanger lip ensures firm support on racks, panels, rails, and carts.
- 4 **Easy Access:** Convenient open hopper front lets you grab small parts effortlessly.
- 5 **Built Tough:** Reinforced side ribs prevent spreading and add durability.
- 6 **Label & Scan Ready:** Large front label area for easy identification and tracking.
- 7 **Space-Saving Design:** Extra-wide stacking ledge keeps bins stable, prevents spills, and optimizes storage capacity.

Caster-Rack Systems Ltd.

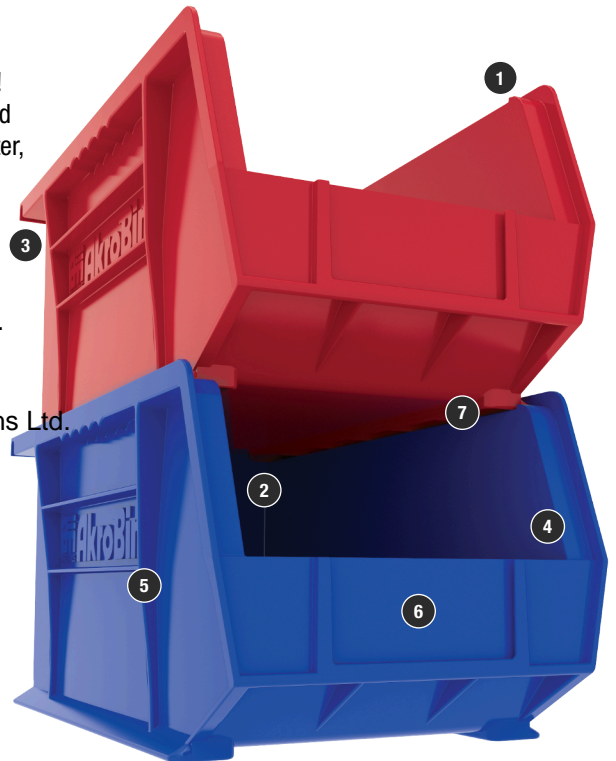

PRODUCT HIGHLIGHTS:

- **Efficient:** Control inventories, shorten assembly times, and minimize parts handling.
- **Functional:** Heavy-duty bins securely stack atop each other, sit on shelving, and hang from racks, panels, rails, and carts.
- **Durable:** Molded of industrial-grade polymers that are resistant to weak acids and alkalis. Water, rust and corrosion-proof.
- **Variety:** Available in many sizes and 7 Standard Colours: Red, Blue, Yellow, Stone, Green, Black and Clear! Other colours available in minimum quantities.

RELATED PRODUCTS:

Create the perfect storage system - mix and match your selection of hanging and stacking bins with the following products.



Wire Shelving Systems

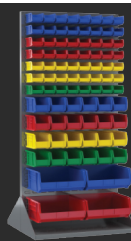

Louvered Hanging Systems

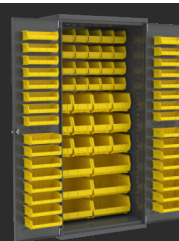

Steel Bin Cabinets



Convertible ProCart

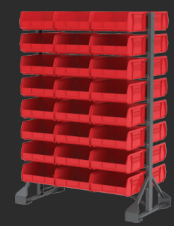

Rail Hanging Systems

HANGING AND STACKING BINS

EFFICIENTLY HANG, STACK, AND ORGANIZE

Standard Colours



30320

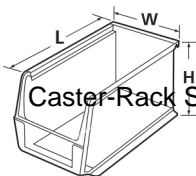
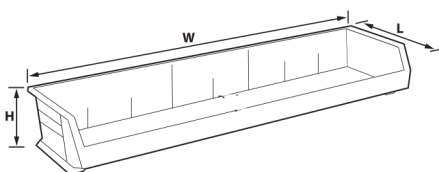

ACCESSORIES:



Length Dividers

Keep contents separated in bin with dividers



Width Dividers

Keep contents separated in bin. Available with select models

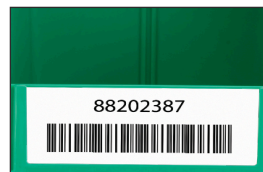

Card Stock Holders
Clearly identify the bin's contents with labels



Clear Lids
Keep contents dust-free and protected (select models)

Hanging and Stacking Bin Accessories		Outside Dimensions (In.)		
Model Number	Description	Width	Height	Package Quantity
29301	Card Stock Holder	3	1	25
29302	Card Stock Holder	4	1-3/4	25

Hanging and Stacking Bins		Outside Dimensions (In.)			Inside Dimensions (In.)			Other Specifications							
Model Number	Colours	Length	Width	Height	Length	Width	Height	Weight (Lbs.)	Capacity (Lbs.)	Carton Quantity	Length Dividers*	Package Quantity	Width Dividers*	Package Quantity	Card Stock
30210	Standard	5-3/8	4-1/8	3	4-3/4	3-7/16	2-13/16	0.21	10	24	40210 (1)	6	-	-	29301
30220	Standard	7-3/8	4-1/8	3	6-3/4	3-7/16	2-13/16	0.29	10	24	40220 (1)	6	-	-	29301
30224	Standard	10-7/8	4-1/8	4	10-1/4	3-3/16	3-3/4	0.53	20	12	40224 (1)	6	-	-	29301
30230	Standard	10-7/8	5-1/2	5	10-1/4	4-3/8	4-3/4	0.83	30	12	40230 (1)	6	41230 (3)	6	29302
30234	Standard	14-3/4	5-1/2	5	14-1/16	4-3/8	4-3/4	1.06	50	12	40234 (1)	6	-	-	29302
30235	Standard	10-7/8	11	5	10-1/4	10	4-3/4	1.50	50	6	40230 (3)	6	-	-	29302
30237	Standard	9-1/4	6	5	8-9/16	4-7/8	4-3/4	0.64	20	12	-	-	-	-	29302
30239	Standard	10-7/8	8-1/4	7	10	6-9/16	6-3/4	1.50	50	6	40239 (1)	6	-	-	29302
30240	Standard	14-3/4	8-1/4	7	14	6-9/16	6-3/4	1.92	60	12	40245 (1)	6	-	-	29302
30250	Standard	14-3/4	16-1/2	7	14	14-3/4	6-3/4	3.17	75	6	40245 (3)	6	41250 (3)	6	29302
30255	Standard	10-7/8	16-1/2	5	9-3/4	15	4-3/4	1.93	60	6	40230 (3)	6	-	-	29302
30260	Standard	18	11	10	17	9-1/2	9-3/4	2.63	60	6	40260 (3)	6	-	-	-
30265	Standard	18	8-1/4	9	17-1/8	6-3/4	8-1/4	2.68	60	6	40265 (1)	6	-	-	-
30270	Standard	18	16-1/2	11	17-1/8	14-3/4	10-1/4	4.59	75	3	40270 (3)	6	41270 (3)	6	-
30320	Blue	8-5/8	33	5	7	31-1/2	4-3/16	3.00	80	4	40321 & 40220 (7)	7 / 6	-	-	-

Other colours and customizations available upon request (minimum orders apply). Order in carton quantities. * () = Max # of divider slots per bin. Dividers sold separately. CAUTION: When using bins with hanging systems, do not exceed the weight capacity for the rack, which may be less than the total sum of bin capacities.



HANGING AND STACKING BINS

EFFICIENTLY HANG, STACK, AND ORGANIZE

Standard Colours



The 30237 fits on 18" deep shelving for a two-bin Kanban system or rotate and pick from both sides.



30240 and 30250 bins paired with 30161 louvered panels.



AWRAIL
(See page 54)



CUSTOM STORAGE SOLUTIONS

Pair Hanging and Stacking Bins with Steel Cabinets, Louver Panels, Rail Systems and Shelving.

ESD Bins – Safeguard Your Sensitive Components

Engineered to protect your most delicate electronics, ESD Bins are built with electrostatic dissipative materials that minimize the risk of static-related damage. Ideal for cleanrooms, electronics assembly areas, and precision tech storage, these bins offer reliable protection, efficient organization, and low-residue handling.

FEATURES:

- 1 **Electrostatic Protection:** Safely dissipates electrostatic charges to prevent damage to sensitive components.
- 2 **Controlled Resistance:** Operates within a static dissipation range of 10^4 to 10^{11} ohms/sq., meeting strict industry standards.
- 3 **Low Carbon Composition:** Contains only 1–2% carbon, preventing residue transfer to parts or sensitive surfaces.

PRODUCT HIGHLIGHTS:

- **Protection:** Prevent costly failures by shielding electronics from harmful electrostatic discharge.
- **Performance:** Built for clean, safe, and efficient storage in ESD-sensitive environments.
- **Clean Handling:** Carbon content low enough to avoid contamination or buildup on stored items.



30210ESD



30220ESD



30230ESD



30235ESD



30240ESD

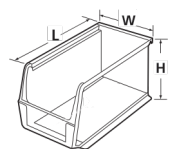

ESD Bins		Outside Dimensions (In.)			Inside Dimensions (In.)			Other Specifications							
Model Number	Colours	Length	Width	Height	Length	Width	Height	Weight (Lbs.)	Capacity (Lbs.)	Carton Quantity	Length Dividers*	Package Quantity	Width Dividers*	Package Quantity	Card Stock
30210ESD	Black	5-3/8	4-1/8	3	4-3/4	3-7/16	2-13/16	0.21	10	24	40210 (1)	6	-	-	29301
30220ESD	Black	7-3/8	4-1/8	3	6-3/4	3-7/16	2-13/16	0.29	10	24	40220 (1)	6	-	-	29301
30230ESD	Black	10-7/8	5-1/2	5	10-1/4	4-3/8	4-3/4	0.83	30	12	40230 (1)	6	41230 (3)	6	29302
30235ESD	Black	10-7/8	11	5	10-1/4	10	4-3/4	1.50	50	6	40230 (3)	6	-	-	29302
30240ESD	Black	14-3/4	8-1/4	7	14	6-9/16	6-3/4	1.92	60	12	40245 (1)	6	-	-	29302

Order in carton quantities. Dividers and lids sold separately.

INSIGHT BINS

ORGANIZE, PROTECT, MAXIMUM VISIBILITY



Standard Colours



Insight Bins – Secure, Smart & Built for Maximum Visibility!

Organize with confidence using our high-performance Insight Bins! Engineered for stability and efficiency, these bins provide a secure stacking system while ensuring quick access to parts and supplies.

FEATURES:

- 1 **Lock-in-Place Stacking:** Unique design keeps bins firmly in place.
- 2 **Strong Hanging Support:** Molded hanger ensures stability on hanging systems.
- 3 **Label & Scan Ready:** Large front label area for easy identification and barcode scanning.
- 4 **Dust-Free Storage:** Optional lids (sold separately) protect contents while allowing bins to stack seamlessly. Optional dividers sold separately.

PRODUCT HIGHLIGHTS:

- **Visibility:** Easily locate and access parts for a more efficient workflow.
- **Versatile:** Securely stacks, hangs from louvered panels, rails, and racks.
- **No-Tip Design:** Stacked bins remain stable, preventing tipping.
- **Durable:** High-impact polycarbonate withstands temperatures up to 250° F and resists wear.
- **Variety:** Available in multiple sizes to suit any storage setup.

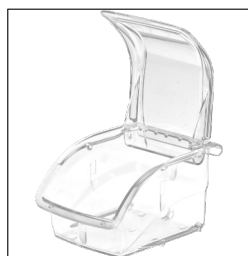

Bins stack with lids in place



Bins stack with lids in place

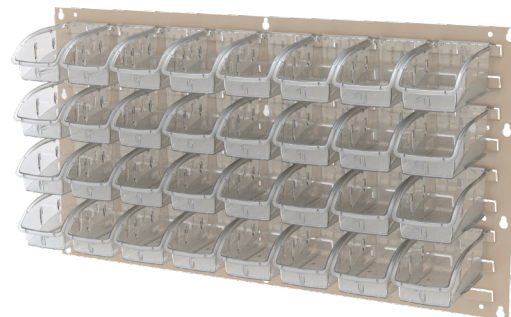
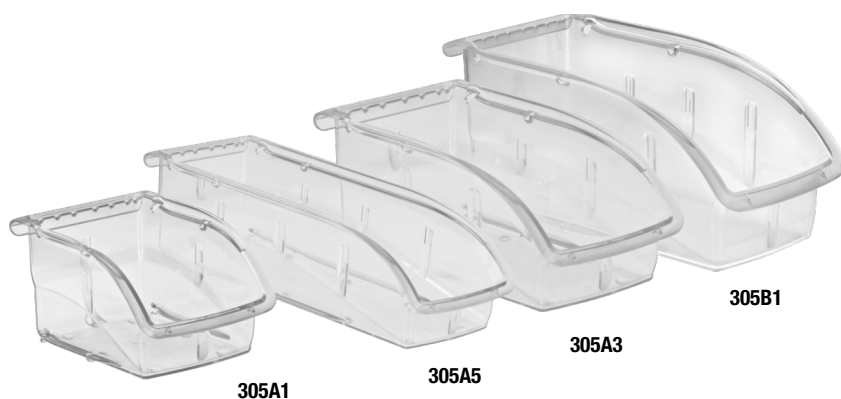

Louvered panel 30636 shown with 305A3 bins

ACCESSORIES:

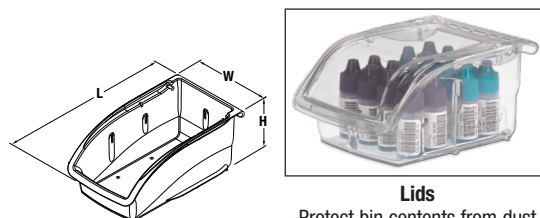

Lids

Protect bin contents from dust

Insight Bins		Outside Dimensions (In.)			Inside Dimensions (In.)			Other Specifications					
Model Number	Colours	Length	Width	Height	Length	Width	Height	Capacity (Lbs.)	Carton Quantity	Lid Model	Package Quantity	Length Dividers	Package Quantity
305A1	Standard	5-3/8	4-1/8	3-1/4	4-1/4	3-1/8	2-5/8	10	16	305A2	16	405A1	8
305A3	Standard	7-3/8	4-1/8	3-1/4	6-1/4	3-1/8	2-5/8	10	16	305A4	16	405A3	8
305A5	Standard	10-7/8	4-1/8	3-1/4	9-1/4	3-1/8	2-5/8	15	12	305A6	12	405A5	6
305B1	Standard	10-7/8	5-1/2	5-1/4	9-7/16	4-1/8	4-7/16	25	12	305B2	12	405B1	6

Order in carton quantities. Dividers and lids sold separately.

4" SHELF BINS

STREAMLINE STORAGE, MAXIMIZE SPACE AND ORGANIZE



4" Shelf Bins – Smart, Space-Saving & Built to Perform!

Boost efficiency with our durable 4" Shelf Bins! Designed for optimal organization and accessibility, these bins maximize storage while ensuring seamless workflow.

FEATURES:

- 1 Convenient Hopper Front:** Wide opening allows effortless retrieval of small parts.
- 2 Smart Tilt-Out Design:** Built-in rear hanglock lets bins tilt for complete access.
- 3 Label-Ready:** Molded-in label area ensures quick identification of contents.
Caster-Rack Systems Ltd.
- 4 Customizable Storage:** Accepts up to 7 dividers (except model 30110) for flexible organization.
- 5 Cold-Resistant:** Performs in temperatures as low as -20°F, ideal for various environments.

PRODUCT HIGHLIGHTS:

- Efficient:** Fits 12", 18", and 24" deep shelving, pick racks, and retrieval units.
- Durable:** Industrial-grade polymer outperforms corrugated bins—waterproof, grease-resistant, and won't crack under heavy loads.
- Nestable:** Bins nest when empty, optimizing storage space.
- Variety:** Available in multiple sizes and colours. Other colours available in minimum quantities.



Accessories available (sold separately)



RELATED PRODUCTS:

Create the perfect storage system - mix and match your selection of shelf bins with the following products.



Wire Shelving Systems

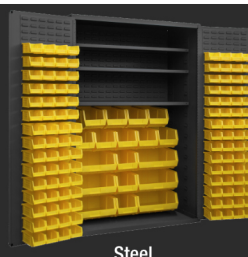

Steel Bin Cabinets



Plastic Bin Cabinets



Steel Pick Racks

4" SHELF BINS

STREAMLINE STORAGE, MAXIMIZE SPACE AND ORGANIZE

Standard Colours

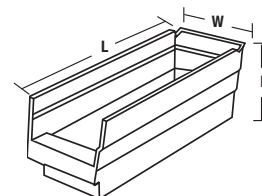
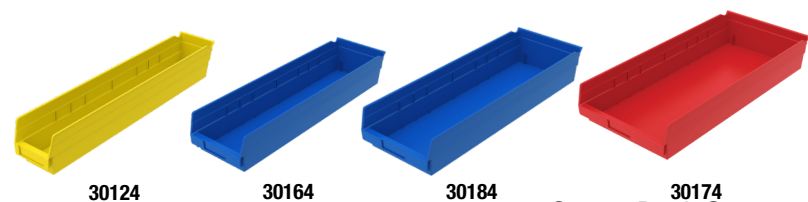
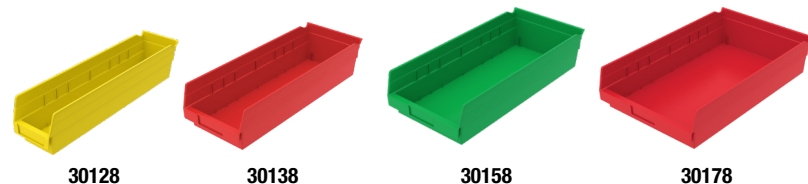
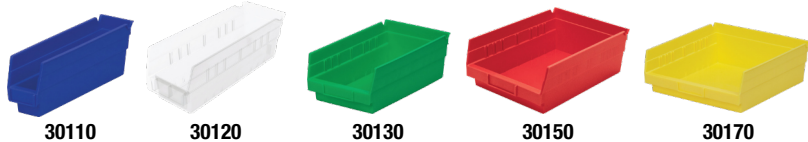

ACCESSORIES:

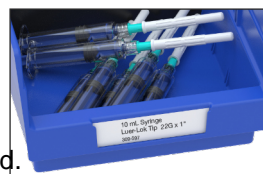

Card Stock Holders
Card stock holders fit in bins existing slot

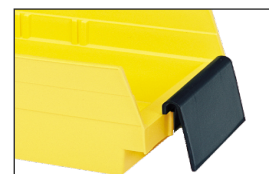

Label Holder
Slips into bins label slot, creates extra large label area



Dividers
Black width dividers available for all sizes (except 30110)



Bin Cups
Lift out easily for parts retrieval (see chart)

Caster-Rack Systems Ltd.

4" Shelf Bin Accessories		Outside Dimensions (In.)			Package Quantity
Model Number	Description	Length	Width	Height	Package Quantity
29300	Card stock label	-	3	13/16	25
30101	2" x 3-1/4" x 3" Small Bin Cup	2	3-1/4	3	48
30102	2-3/4" x 5" x 3" Large Bin Cup	2-3/4	5	3	24
40410*	10° Angle Label Holder	-	4	2-3/8	24/Pkg.
40445*	45° Angle Label Holder	-	4	2-3/8	24/Pkg.

*Fits all 4"H shelf bins except 30110.

4" Shelf Bins		Outside Dimensions (In.)			Inside Dimensions (In.)			Capacity/Quantity				Cups per Bin		Accessories		
Model Number	Colours	Length	Width	Height	Length	Width	Height	Weight (Lbs.)	Capacity (Lbs.)	Volume (Cu. In.)	Carton Quantity	Small 30101	Large 30102	Width Dividers*	Package Quantity	Card Stock
30110	Standard	11-5/8	2-3/4	4	10-1/4	1-5/8	4	0.29	7.00	54	24	3	-	-	-	29300**
30120	Standard	11-5/8	4-1/8	4	10-1/4	3	4	0.38	10.00	78	24	5	2	40120 (7)	24	29300
30130	Standard	11-5/8	6-5/8	4	10-1/4	5-1/2	4	0.51	15.00	128	12	9	4	40130 (7)	24	29300
30150	Standard	11-5/8	8-3/8	4	10-1/4	7-1/8	4	0.65	15.00	138	12	11	4	40150 (7)	24	29300
30170	Standard	11-5/8	11-1/8	4	10-1/4	10	4	0.80	20.00	197	12	15	6	40170 (7)	24	29300
30128	Standard	17-7/8	4-1/8	4	16-1/2	3	4	0.58	15.00	123	12	8	3	40120 (7)	24	29300
30138	Standard	17-7/8	6-5/8	4	16-1/2	5-1/2	4	0.68	20.00	176	12	15	6	40130 (7)	24	29300
30158	Standard	17-7/8	8-3/8	4	16-1/2	7-1/8	4	1.00	20.00	214	12	15	6	40150 (7)	24	29300
30178	Standard	17-7/8	11-1/8	4	16-1/2	10	4	1.10	20.00	292	12	25	12	40170 (7)	24	29300
30124	Standard	23-5/8	4-1/8	4	22-1/8	3	4	0.85	20.00	199	12	11	4	40120 (7)	24	29300
30164	Standard	23-5/8	6-5/8	4	22-1/8	5-1/2	4	1.21	20.00	321	6	21	8	40130 (7)	24	29300
30184	Standard	23-5/8	8-3/8	4	22-1/8	7-1/8	4	1.40	20.00	346	6	25	8	40150 (7)	24	29300
30174	Standard	23-5/8	11-1/8	4	22-1/8	10	4	1.97	20.00	513	6	35	16	40170 (7)	24	29300

Order in carton quantities. Other colours and customizations available upon request (minimum orders apply). * () = Max # of divider slots per bin. Dividers sold separately. **29300 must be cut to length to fit 30110.

6" SHELF BINS

STREAMLINE STORAGE, MAXIMIZE SPACE AND ORGANIZE



6" Shelf Bins – High Capacity, High Performance!

Reimagine your shelving efficiency with our ultra-capable 6" Shelf Bins! Built for strength, accessibility, and smart organization, these bins offer 85% more storage capacity than standard 4" bins, without compromising on durability or space-saving design.

FEATURES:

- Enhanced Access:** Front opening is $\frac{3}{4}$ " taller than comparable bins for easier reach.
- Reinforced Design:** Side ribs and rolled ridge add structural integrity when fully loaded.
- Label-Friendly:** Large front label area for streamlined identification and scanning.
- Complete Accessibility:** Rear hanglock allows the bin to tilt out for full access.
- Flexible Storage:** Optional dividers and cups available for custom compartment configurations.



PRODUCT HIGHLIGHTS:

- Superior Capacity:** Delivers 85% more space than traditional 4" bin options.
- Compatibility:** Compatible with steel and wire shelving, pick racks, and bench racks.
- Durable:** Outperforms corrugated bins with rugged, one-piece construction.
- Variety:** Available in a range of sizes and colours. Custom colours available with minimum quantities.



RELATED PRODUCTS:

Create the perfect storage system - mix and match your selection of shelf bins with the following products.



Wire Shelving Systems

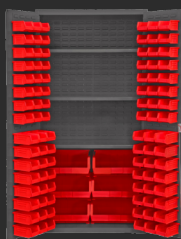

Steel Bin Cabinets

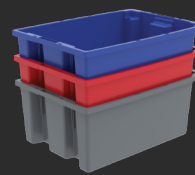

Stack and Nest Containers



Steel Pick Racks



6" SHELF BINS

STREAMLINE STORAGE, MAXIMIZE SPACE AND ORGANIZE

Standard Colours



30090



30080



30040



30080

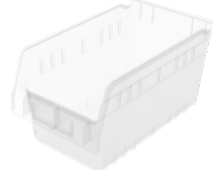

30090



30048



30098



30088



30094

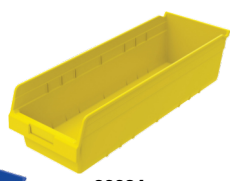

30084



30014

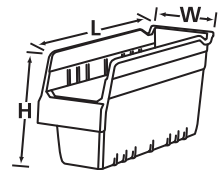

ACCESSORIES:



Card Stock Holders
Card stock holders fit in bins existing slot

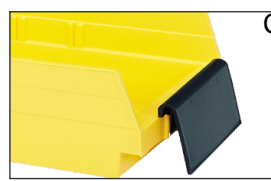

Label Holder
Slips into bins label slot, creates extra large label area



Dividers
Black width dividers available for all sizes

Caster-Rack Systems Ltd.

6" Shelf Bin Accessories		Outside Dimensions (In.)			Carton Quantity
Model Number	Description	Length	Width	Height	
40410	10° Angle Label Holder	3/10	4	2-3/8	24/Pkg.
40445	45° Angle Label Holder	3/10	4	2-3/8	24/Pkg.

6" Shelf Bins		Outside Dimensions (In.)			Inside Dimensions (In.)			Capacity/Quantity				Accessories		
Model Number	Colours	Length	Width	Height	Length	Width	Height	Weight (Lbs.)	Capacity (Lbs.)	Volume (Cu. In.)	Carton Quantity	Width Dividers*	Package Quantity	Card Stock
30040	Standard	11-5/8	4-1/8	6	9-3/4	2-1/2	5-15/16	0.55	20	175	16	40020 (7)	12	29301
30090	Standard	11-5/8	6-5/8	6	9-3/4	5	5-15/16	0.71	30	310	10	40030 (7)	12	29301
30080	Standard	11-5/8	8-3/8	6	9-3/4	6-5/8	5-15/16	0.89	35	398	8	40040 (7)	12	29301
30048	Standard	17-7/8	4-1/8	6	16	2-1/2	5-15/16	0.83	25	280	8	40020 (7)	12	29301
30098	Standard	17-7/8	6-5/8	6	16	5	5-15/16	1.04	35	505	10	40030 (7)	12	29301
30088	Standard	17-7/8	8-3/8	6	16	6-5/8	5-15/16	1.25	35	648	8	40040 (7)	12	29301
30094	Standard	23-5/8	6-5/8	6	21-3/4	5	5-15/16	1.43	35	686	10	40030 (7)	12	29301
30084	Standard	23-5/8	8-3/8	6	21-3/4	6-5/8	5-15/16	1.98	35	935	6	40040 (7)	12	29301
30014	Standard	23-5/8	11-1/8	6	21-3/4	9-1/2	5-15/16	2.38	35	1303	6	-	-	29301

Other colours and customizations available upon request (minimum orders apply). Order in carton quantities. * () = Max # of divider slots per bin. Dividers sold separately.



INDICATOR BINS

TWO-TONE INVENTORY CONTROL BIN

Standard Colours

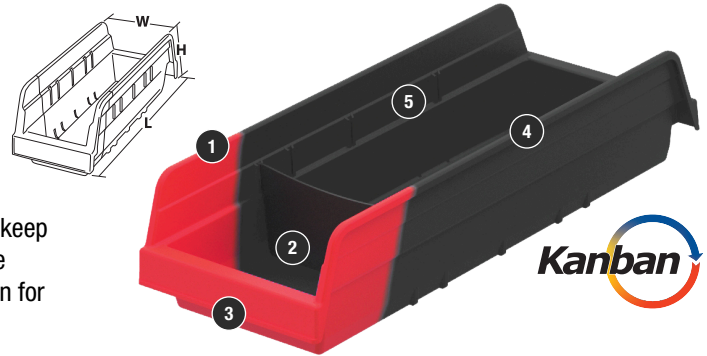

Indicator Bins – Smarter Inventory at a Glance!

Streamline your stock management with Indicator Bins—designed to keep you ahead of supply shortages. With dual-colour visibility and a unique double-hopper design, these bins offer a simple, cost-effective solution for tracking inventory in real time.

FEATURES:

- 1 **Visual Alerts:** Bright orange/red trigger colour signals low inventory at a glance.
- 2 **Dual Access:** Fill and pick from either side with the clever double-hopper format.
- 3 **Easy Identification:** Large label areas on both sides support part tracking and bar coding.
- 4 **Reinforced Strength:** Rolled ridge provides durability even under load.
- 5 **Flexible Configuration:** Optional width dividers separate active and reserve stock for precision control.

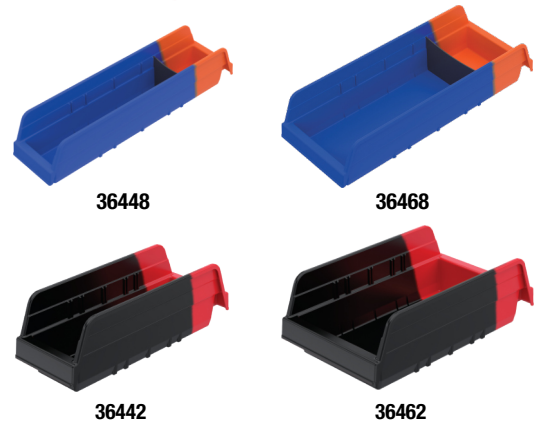

PRODUCT HIGHLIGHTS:

- **Inventory Control:** Prevents stock outages before they happen.
- **Easy to Use:**
 - Stock:** Use a divider to set aside reserve inventory.
 - Pick:** Draw from the blue/black side until you reach the divider.
 - Flip:** Turn the bin to expose the orange/red side, your cue to restock.
 - Replenish:** Refill and reset for another smooth inventory cycle.
- **Value:** A smart, low-cost alternative to expensive inventory software systems.



Stock | Pick | Flip | Replenish

ACCESSORIES:

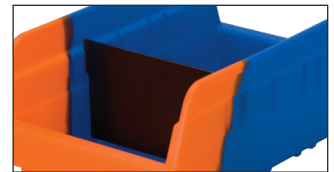

Width Dividers
Available for all sizes

Indicator

Indicator Bins		Outside Dimensions (In.)			Inside Dimensions (In.)			Other Specifications				
Model Number	Colours	Length	Width	Height	Length	Width	Height	Weight (Lbs.)	Capacity (Lbs.)	Carton Quantity	Dividers*	Package Quantity
36442	Standard	11-5/8	4-1/4	4	9-7/8	2-7/8	3-7/8	0.39	10	24	40120 (5)	24
36462	Standard	11-5/8	6-3/4	4	9-7/8	5-3/8	3-7/8	0.54	15	12	40130 (5)	24
36448	Standard	17-7/8	4-1/8	4	16-1/8	2-3/4	3-7/8	0.63	15	12	40442 (5)	12
36468	Standard	17-7/8	6-5/8	4	16-1/8	5-1/4	3-7/8	0.82	20	12	40462 (5)	12

* () = Max # of divider slots per bin. Dividers sold separately.

RELATED PRODUCTS:

Create the perfect storage system - mix and match your selection of indicator shelf bins with the following products.

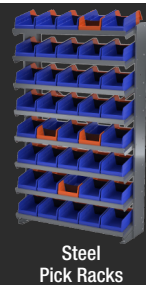
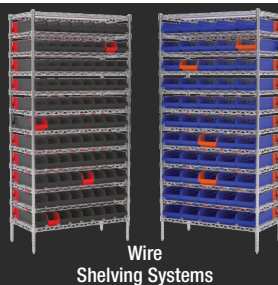

SHELF AND STACK BINS

TOUGH, ORGANIZED, RELIABLE STORAGE SOLUTIONS



Standard Colours



High Visibility Stack and Shelf Bins – Visibility Meets Efficiency

When visibility and accessibility matter most, our Stack and Shelf Bins deliver. Designed for shelving and racking systems, these bins bring streamlined organization to every storage environment.

PRODUCT HIGHLIGHTS:

- **Visibility:** Large hopped front provides excellent visibility and easy reach.
- **Compatibility:** Compatible with standard steel and wire shelving and racks.
- **Durable:** Resistant to weak acids, alkalis, water, rust, and corrosion.
- **Label & Organize:** Large label area ensures quick part identification and smooth inventory tracking.
- **Stackable:** AW30600 and AW30605 are stackable for space-saving setups. AW30550 is ideal for long items; optional rear-hole version available for bin chaining (minimum orders apply).

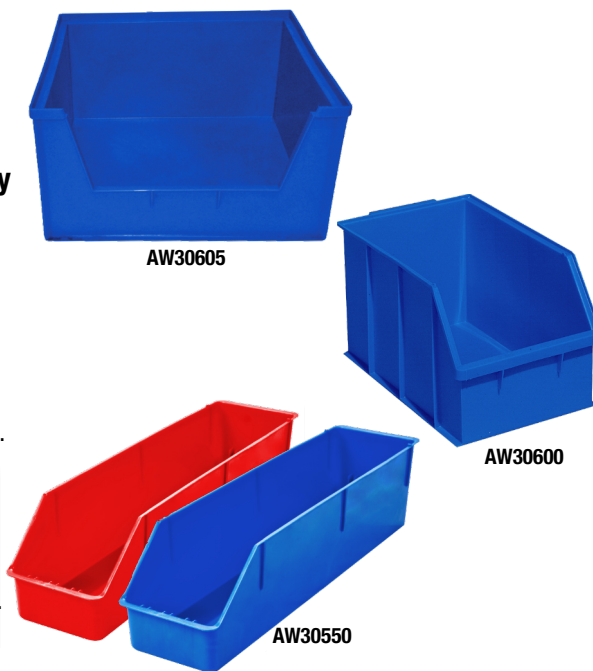

Stack and Shelf Bins		Outside Dimensions (In.)			Inside Dimensions (In.)			Other Specifications		
Model Number	Colours	Length	Width	Height	Length	Width	Height	Weight (Lbs.)	Capacity (Lbs.)	Carton Quantity
AW30550	Standard	24-1/4	6	5-13/16	22-1/4	5	5-5/8	1.40	20	8
AW30600	Blue	18	10-3/8	10	15-3/4	9-1/8	9-13/16	2.80	50	4
AW30605	Blue	16	16	8-1/8	14-11/16	14-11/16	7-11/16	2.30	50	1

Other colours and customizations available upon request (minimum orders apply). Order in carton quantities.

Standard Colours



30348



Removable divider for increased flexibility



Large front label area for content identification



Wide hopper front for easy access

1800 Series Bins – Built Tough for Oversized Organization

When you're storing heavy-duty, bulky items, the 1800 Series Bins provide unmatched strength, stability, and custom configuration options.

FEATURES:

- 1 **Heavy-Duty Construction:** Molded from industrial-grade polymers for exceptional impact resistance and long-term durability.
- 2 **Stacking Strength:** Reinforcing ribs and wide walls prevent deformation—even when bins are stacked and fully loaded.
- 3 **Customizable Storage:** Each bin includes one black width divider, making it easy to separate parts or materials for better organization.

PRODUCT HIGHLIGHTS:

- **Durable:** Built to endure harsh environments and demanding loads.
- **Stackable:** Maximize space with bins designed to stack securely.
- **Dividable:** Easily create segmented compartments with divider.

1800 Series Bins		Outside Dimensions (In.)			Inside Dimensions (In.)			Other Specifications				
Model Number	Colours	Length	Width	Height	Length	Width	Height	Weight (Lbs.)	Capacity (Lbs.)	Carton Quantity	Dividers*	Package Quantity
30348	Standard	20-1/2	8-1/4	7	20	7-3/8	6-1/2	3.33	60	6	40348 (3)	6
30358	Standard	20-1/2	11	7	20	10-1/8	6-1/2	4.37	75	6	40358 (3)	6

Order in carton quantities. * () = Max # of divider slots per bin. Dividers sold separately.



SHELF BINS

SPACE SAVING, DURABLE, SHELF-READY

Standard Colours

BK

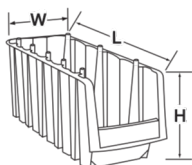

Stack-Nest Shelf Bins – Nesting, Stacking & Shelf-Smart

Maximize space without sacrificing access with Stack-Nest Shelf Bins, designed to nest, stack, and fit snugly on standard shelving. These efficient bins bring durable, dual-function performance to any workspace.

PRODUCT HIGHLIGHTS:

- **Versatile:** Perfectly sized for 12" or 18" deep shelving, stack between shelves or nest when empty.
- **Durable:** Made from industrial-grade polymers built to last.
- **Exclusive Design:** Small parts bin with nest-and-stack capability.
- **Efficient Access:** Wide front opening makes retrieving items quick and easy.

Stack-Nest Bins		Outside Dimensions (In.)			Inside Dimensions (In.)			Other Specifications		
Model Number	Colours	Length	Width	Height	Length	Width	Height	Weight (Lbs.)	Capacity (Lbs.)	Carton Quantity
30796	Standard	8-7/8	6-5/8	5	6-5/8	4	4-15/16	0.58	6	10
30716	Standard	11-7/8	6-5/8	5	9-1/2	4	4-15/16	0.78	12	10
30718	Standard	11-7/8	8-3/8	5	9-1/2	5-3/4	4-15/16	0.96	15	8
30776	Standard	17-7/8	6-5/8	7	15-1/4	3-3/4	6-15/16	1.30	24	10
30778	Standard	17-7/8	8-3/8	7	15-3/8	5-1/2	6-15/16	1.61	24	8

Order in carton quantities.

Caster-Rack Systems Ltd.

Standard Colours

BL

System Bins – One-Piece, Space-Saving & Shelf-Ready

Designed to streamline part storage, System Bins are injection-molded, single-piece units sized perfectly for standard shelving and workstations.

FEATURES:

- 1 **Six-Across Configuration:** Measures 33" wide × 5" high, fits on 36" steel or wire shelving.
- 2 **Stackable & Nestable:** Stack with a 3/8" dowel rod (not included); nest when empty to conserve space.
- 3 **Available Depths:** Choose 12" or 18" models.
 - 30312 Inside Bin Dimensions: 10-3/8"L × 3-5/8"W
 - 30318 Inside Bin Dimensions: 16-3/8"L × 3-5/8"W

SystemBins™



30312

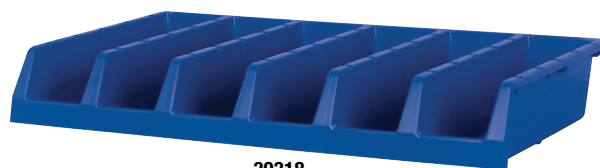

30318

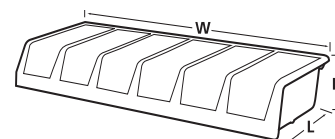

PRODUCT HIGHLIGHTS:

- **Single-Piece:** Six-bin integrated unit eliminates the need for assembly.
- **Durable:** Rigid structure outlasts cardboard alternatives.
- **Value:** Cost-effective, space-optimizing solution for part storage.

System Bins		Outside Dimensions (In.)			Inside Dimensions (In.)*			Other Specifications	
Model Number	Colours	Length	Width	Height	Length	Width	Height	Weight (Lbs.)	Carton Quantity
30312	Standard	12	33	5	10-3/8	3-5/8	4-15/16	2.37	5
30318	Standard	18	33	5	16-3/8	3-5/8	4-15/16	4.05	5

Order in carton quantities. *Bottom inside dimensions per compartment.

DRAWER BINS

HEAVY DUTY STORAGE DRAWERS



Standard Colours



Drawer Bins – Organized. Durable. Ready for Anything.

From hardware to healthcare, keep your supplies protected and organized with our versatile Drawer Bins. Built for high performance and easy integration, they offer secure storage, flexible configurations, and lasting durability, perfect for work spaces that demand order and efficiency.

FEATURES:

- 1 **Hang with Confidence:** Sturdy backstop tab ensures secure hanging on shelves.
- 2 **Ergonomic Handling:** Wide front handle provides easy grip—even when fully loaded.
- 3 **Label-Ready Design:** Large front label area simplifies part identification and bar coding.
- 4 **Flexible Storage:** Multiple divider slots allow customized compartment setups.

PRODUCT HIGHLIGHTS:

- **Protection:** Keeps tools, components, and supplies protected from dirt, and debris.
- **Versatile:** Compatible with Pick Racks and Enclosed Steel Shelving systems.
- **Durable:** Colour Drawer Bins are made from high-impact polystyrene for superior strength; Crystal Clear Drawer Bins are made from a durable acrylic blend for visibility and resilience.
- **Stackable:** Maximize your space by stacking bins when needed.
- **Variety:** Multiple options to match your unique storage setup. Other colours available with minimum quantities.

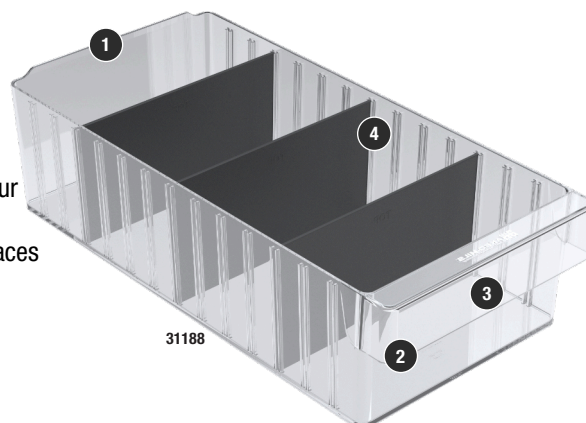

31188

ACCESSORIES:

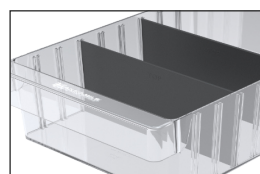

Width Dividers
Available for all sizes

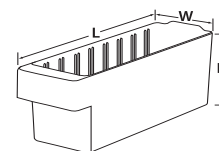

31168

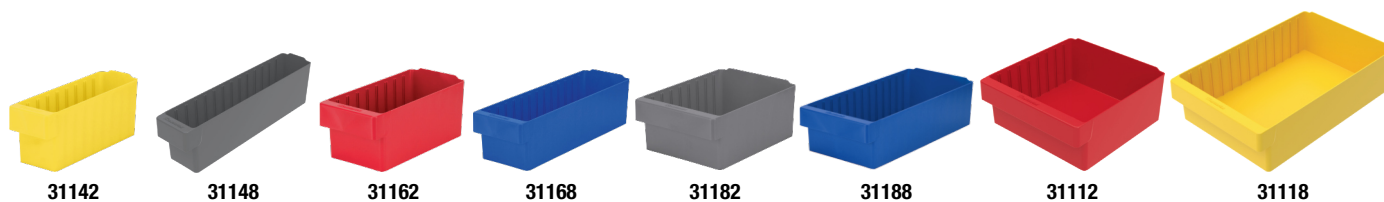

Drawer Bins		Outside Dimensions (In.)			Inside Dimensions (In.)			Other Specifications				
Model Number	Colours	Length	Width	Height	Length	Width	Height	Weight (Lbs.)	Capacity (Lbs.)	Carton Quantity	Dividers*	Package Quantity
31142	Standard	11-5/8	3-3/4	4-5/8	10-1/4	3-1/16	4-7/16	0.80	15	6	41440 (8)	6
31162	Standard	11-5/8	5-9/16	4-5/8	10-1/4	4-7/8	4-7/16	0.97	20	6	41460 (8)	6
31182	Standard	11-5/8	8-3/8	4-5/8	10-1/4	7-5/8	4-7/16	1.30	20	4	41480 (8)	6
31112	Standard	11-5/8	11-1/8	4-5/8	10-1/4	10-7/16	4-7/16	1.59	25	4	41410 (8)	8
31148	Standard	17-5/8	3-3/4	4-5/8	16-1/4	3-1/16	4-7/16	1.09	20	6	41440 (13)	6
31168	Standard	17-5/8	5-9/16	4-5/8	16-1/4	4-7/8	4-7/16	1.57	25	6	41460 (13)	6
31188	Standard	17-5/8	8-3/8	4-5/8	16-1/4	7-5/8	4-7/16	2.09	25	4	41480 (13)	6
31118	Standard	17-5/8	11-1/8	4-5/8	16-1/4	10-7/16	4-7/16	2.25	25	4	41410 (13)	8

Other colours and customizations available upon request (minimum orders apply). Order in carton quantities. * () = Max # of divider slots per bin. Dividers sold separately.

STACKING BINS

STRONG, SPACIOUS & BUILT TO LAST



Stacking Bins – Strong, Spacious & Built to Last!

Take control of your storage with our heavy-duty Stacking Bins! Designed for maximum capacity and efficiency, these bins keep your workspace organized while ensuring easy access to parts and supplies.

FEATURES:

- 1 **Reinforced Strength:** Side ribs prevent spreading and add durability.
- 2 **Stay Put:** Anti-slide stop keeps stacked bins securely in place.
- 3 **Label & Organize:** Large front label area for easy coding and scanning.
- 4 **Customizable Compartments:** Divider slots allow flexible storage solutions.
- 5 **Easy to Carry:** Large molded handle on the back for effortless transport.

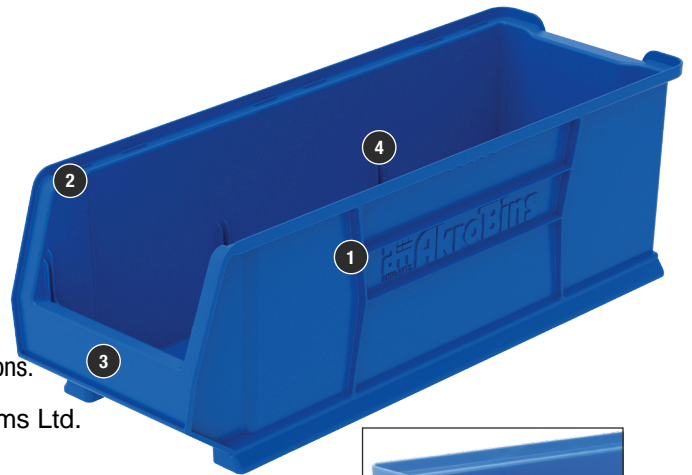

PRODUCT HIGHLIGHTS:

- **Capacity:** Large-capacity storage to improve organization and workflow.
- **Stackable:** Heavy-duty bins securely stack on top of each other, sit on shelving, carts, or dollies.
- **Durable:** Molded of industrial-grade polymers and are resistant to weak acids and alkalis. Water, rust, and corrosion-proof.
- **Variety:** Available in multiple sizes and colours to match your needs.



RELATED PRODUCTS:

Create the perfect storage system - mix and match your selection of stacking bins with the following products.



Wire Shelving Systems



Shelf Bins

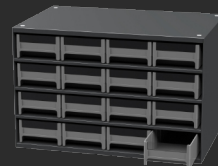

Steel Cabinets

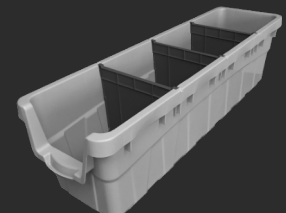

Rack Bins

STACKING BINS

STRONG, SPACIOUS & BUILT TO LAST



Standard Colours



AK74-2448282Y-CHROME
Super-Size Bin Wire System

Wire SHELVING KITS
Chrome vs Epoxy

Shelf kits are available in both chrome or grey epoxy finish. Chrome plated finish is very durable and is ideal for dry storage environments. Grey epoxy is the ideal solution for high humidity, wet, or walk-in-cooler applications. Specify finish when ordering.

See page 58-62 for more information.

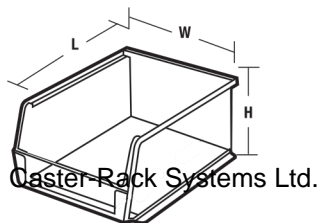

ACCESSORIES:



Length Dividers
Available on select models



Width Dividers
Available on select models

Stacking Bins		Outside Dimensions (In.)			Inside Dimensions (In.)			Other Specifications			Length Dividers		Width Dividers	
Model Number	Colours	Length	Width	Height	Length	Width	Height	Weight (Lbs.)	Capacity (Lbs.)	Carton Quantity	Length Dividers*	Package Quantity	Width Dividers*	Package Quantity
30280	Standard	20	12-3/8	6	16-7/8	10-11/16	5-3/8	2.17	200	4	40280 (3)	2	-	-
30281	Standard	20	12-3/8	8	16-7/8	10-11/16	7-3/8	2.57	200	3	40281 (3)	3	-	-
30282	Standard	20	12-3/8	12	16-7/8	10-11/16	11-3/8	3.38	200	2	40282 (3)	1	-	-
30283	Standard	20	18-3/8	12	16-7/8	16-9/16	11-3/8	7.00	300	1	40283 (3)	1	-	-
30284	Standard	23-7/8	8-1/4	7	20-7/8	6-3/8	6-1/8	3.00	200	4	40286 (1)	4	41284 (2)	2
30286	Standard	23-7/8	11	7	20-7/8	9-1/8	6-1/8	3.85	200	4	40286 (3)	4	41286 (2)	2
30287	Standard	23-7/8	11	10	20-3/4	9	9-1/8	4.97	300	4	40287 (3)	6	41287 (2)	6
30288	Standard	23-7/8	16-1/2	11	20-3/4	14-3/8	10-1/8	7.20	300	1	40287 (3)	6	41288 (2)	6
30289	Standard	23-7/8	18-1/4	12	20-3/4	16	11-1/8	8.39	300	1	-	-	41289 (2)	2
30290	Standard	29-1/4	18-3/8	12	26-1/8	16-9/16	11-3/8	6.86	300	1	40290 (3)	1	-	-
30292	Standard	29-7/8	11	10	26-3/4	9	9-1/8	5.65	300	4	40292 (3)	6	41287 (2)	6
30293	Standard	29-7/8	16-1/2	11	26-3/4	14-3/8	10-1/8	8.20	300	1	40292 (3)	6	41288 (2)	6

Other colours and customizations available upon request (minimum orders apply). Order in carton quantities. * () = Max # of divider slots per bin. Dividers sold separately.



STACK-N-STORE BINS

STRONG, SPACIOUS & BUILT FOR HEAVY-DUTY STORAGE

Standard Colours



Stack-N-Store Bins – Strong & Built for Heavy-Duty Storage!

Maximize your storage efficiency with our rugged Stack-N-Store Bins! Designed for durability and convenience, these bins provide easy access to bulky items while ensuring a stable, space-saving stacking system.

FEATURES:

- 1 **Reinforced Strength:** Large radius corners and rolled rim add durability.
- 2 **Stable Stacking:** Side ribs offer enhanced stability for secure stacking.
- 3 **Easy Access:** Wide hopper front makes retrieving bulky items effortless.
- 4 **Comfortable Handling:** Large grip handles for easy lifting and transport.

PRODUCT HIGHLIGHTS:

- **Stackable:** Bins stack to form tall, stable storage arrangements on floors or standard industrial shelving.
- **Durable:** Industrial-grade polymer will not rust, corrode or bend out of shape even when fully loaded.
- **Cost-Effective:** Longer service life resulting in lower replacement costs.
- **Variety:** Available in 3 sizes and multiple colours. Other colours available in minimum quantities.



AK74-1848017B-CHROME
Stack and Store Bin Wire System



Side ribs add reinforcement for stacking stability



Large hopper front for easy access



Large comfort grip handles for easy lifting



13017

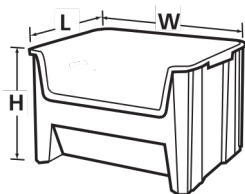

Stack-N-Store Bins		Outside Dimensions (In.)			Inside Dimensions (In.)			Other Specifications				
Model Number	Colours	Length	Width	Height	Length	Width	Height	Volume (Cu. Ft.)	Volume (Gal.)	Capacity (Lbs.)	Stack Height	Carton Quantity
13014	Standard	17-1/2	10-7/8	12-1/2	15-5/8	8	12-1/4	0.98	7.40	75	3	4
13017	Standard	15-1/4	19-7/8	12-7/16	13-5/8	17-1/2	12-1/4	1.70	12.70	75	3	3
13018	Standard	17-1/2	16-1/2	12-1/2	15-5/8	13-3/4	12-1/4	1.60	12.00	75	3	2

Other colours and customizations available upon request (minimum orders apply). Order in carton quantities.

TILTVIEW BINS

EASY ACCESS, VISIBLE, DUST-FREE STORAGE

Standard Colours

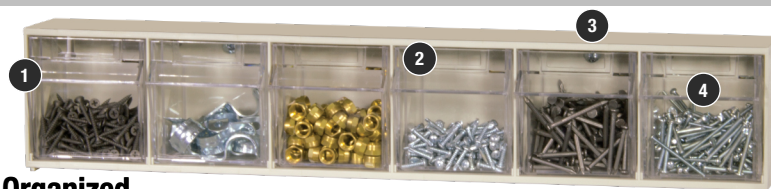

TiltView® Bins – Clear, Compact & Effortlessly Organized

Maximize visibility and minimize clutter with TiltView® bins, your go-to solution for efficient, dust-free storage. These space-saving units tilt smoothly for easy access and can be mounted virtually anywhere.

FEATURES:

- 1 **Tilt-Out Access:** Bins tilt open effortlessly and can be removed for cleaning or restocking.
- 2 **Crystal-Clear Visibility:** Transparent bin cups allow for quick content identification while keeping items protected from dust.
- 3 **Flexible Mounting:** Use on desktops, or mount to steel rails, frames, louvered panels, or directly to walls.
- 4 **Label-Ready:** Molded-in label holders with included card stock labels make organization simple and clear.
- 5 **Modular:** 06702 can slide apart to create two separate bins for added flexibility.

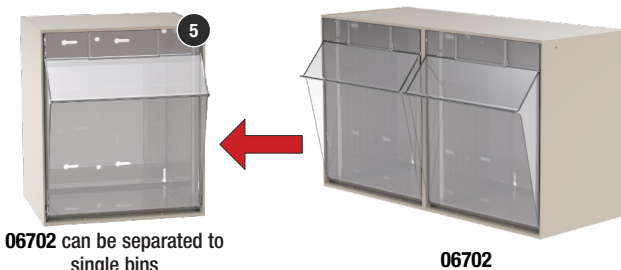

PRODUCT HIGHLIGHTS:

- **Efficient:** Space-saving design enhances organization and workflow in any environment, ideal for medical, pharmacy, and industrial settings.
- **Functional:** Versatile mounting and placement options adapt to your workspace needs.
- **Durable:** Cabinets made from high-impact polystyrene; bins made from GPS polystyrene for long-lasting performance.
- **Variety:** Available in multiple sizes to suit a wide range of storage applications.

Caster-Rack Systems Ltd.



Bins stack securely

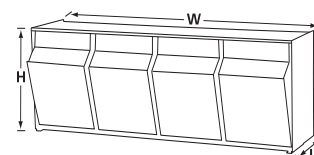

TiltView Bins		Outside Dimensions (In.)			Bin Cup Dimensions (In.)			Other Specifications		
Model Number	Colours	Length	Width	Height	Length	Width	Height	Weight (Lbs.)	Capacity (Lbs.)	Bin Quantity
06702	Standard	12-5/16	23-5/8	14	8-5/8	10-7/16	13-1/8	14.15	30	2
06703	Standard	7-7/8	23-5/8	9-7/16	5-5/8	6-7/8	8-5/8	7.30	30	3
06704	Standard	6-3/4	23-5/8	8-3/16	4-3/4	4-7/8	7-3/8	6.00	25	4
06705	Standard	5-3/8	23-5/8	6-1/2	3-3/8	3-7/8	5-3/4	3.90	20	5
06706	Standard	3-3/4	23-5/8	4-1/2	2-1/2	3	3-3/4	1.95	15	6



RACKABLE BINS

DURABLE, SPRINKLER-SAFE COMPLIANT

Standard Colours

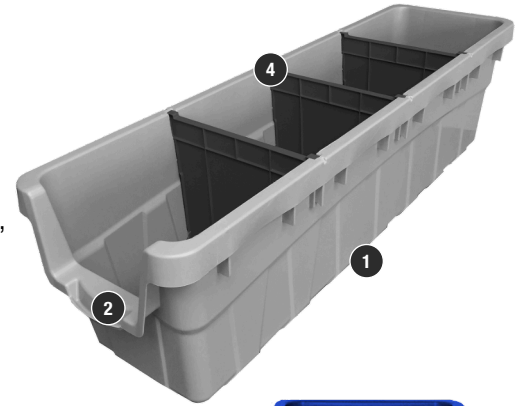

AK42121203



AK421212DIVIDER

Rackable Bins – Durable, Organized, Fire-Safe

Maximize storage and workflow with robust bins designed for pallet racking, SKU control, and sprinkler-safe compliance.

FEATURES:

- 1 **Rack-Optimized:** Designed to fit perfectly in 42" deep racks.
- 2 **Safe & Ergonomic:** Heavy-duty grips on front, back, and sides for secure handling
- 3 **Stable:** Designed for stable stacking, wide stacking ledge prevent forward shifting
- 4 **Flexible Organization:** Warehouse Bin has optional lockable dividers support up to 8 SKUs per bin.
- 5 **Drainage & Airflow Options:**
 - **AK42121203:** Perforated bottom allows water drainage during sprinkler activation.
 - **QRB Rack Bin:** Eight 1/4" drill holes on base enable customized airflow or drainage.

PRODUCT HIGHLIGHTS:

- **Maximized Space:** Full length bins eliminate wasted space in deep racks.
- **Organizational:** Large labeling area for barcode and SKUs.
- **Secure Stacking:** QRB Rack Bin: Anti-slide lock and multi-point grips for safety in motion.
- **Environmental Readiness:** Drainage-ready designs support operational and fire compliance.

Resistance: Waterproof and corrosion-free for harsh environments, built for long-term reusability and safety.



QRB166



QRB206



QRB246

Rackable Bins		Outside Dimensions (In.)			Inside Dimensions (In.)			Other Specifications			
Model Number	Colours	Length	Width	Height	Length	Width	Height	Weight (Lbs.)	Capacity (Lbs.)	Dividers*	Package Quantity
AK42121203	Standard	42	11-3/5	11-1/2	39-3/4	8-7/8	11	4.50	-	AK421212DIVIDER (7)	1
QRB166	Standard	41-7/8	16-1/2	17-1/2	40-1/8	14	16-1/2	16	180	-	-
QRB206	Standard	41-7/8	19-7/8	17-1/2	40-1/8	17-3/8	16-1/2	17	180	-	-
QRB246	Standard	41-7/8	23-7/8	17-1/2	40-1/8	21-1/2	16-1/2	19	180	-	-

Other colours and customizations available upon request (minimum orders apply). * () = Max # of divider slots per bin. Dividers sold separately.

STACK AND NEST CONTAINERS

SMART, STRONG, SPACE-SAVING STORAGE



Stack and Nest Containers – Durable, Versatile & Built for Efficient Storage!

Optimize your storage and transport with our high-performance Stack and Nest Containers! Engineered for strength, convenience, and security, these containers are perfect for shipping, transfer, and storage applications.

FEATURES:

- 1 **Easy-to-Clean:** Smooth surfaces allow for effortless maintenance.
- 2 **Comfortable Grip:** Ergonomic design makes lifting and handling easy.
- 3 **Jam-Free Nesting:** Ribbs under the lip prevent sticking when nested.
- 4 **Slip-Resistant Base:** Textured bottom ensures stability on concrete floors.
- 5 **Secure Stacking:** Wide stacking ledge keeps totes stable—even without lids.
- 6 **Extra Protection:** Optional lids feature tie holes for enhanced security.



PRODUCT HIGHLIGHTS:

- **Functional:** Ideal for shipping, transfer, and storage applications.
- **Stackable & Nestable:** Stack securely when full, nest when empty to save space.
- **Durable:** Industrial-grade polymer resists rust, corrosion, and warping under heavy loads.
- **Cost-Effective:** Long service life means fewer replacements and lower costs.
- **FDA-Compliant:** Manufactured from materials safe for regulated environments.
- **Variety:** Available in multiple sizes and colours. Other colours available in minimum quantities.

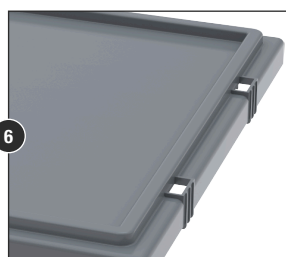

RELATED PRODUCTS:

Create the perfect storage system - mix and match your selection of stack and nest containers with the following products.

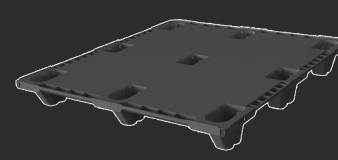
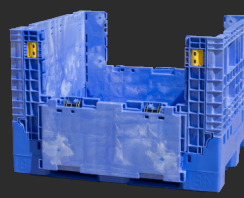
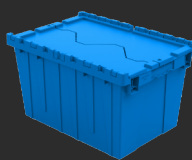

STACK AND NEST CONTAINERS

SMART, STRONG, SPACE-SAVING STORAGE



Standard Colours



35180



35190



35200



35185



35195



35225



35240



35230



35300

Label Holders		
Model Number	Label Size	Package Qty
35010	5" x 3-3/4"	6

ACCESSORIES:

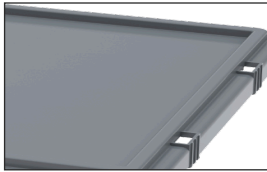

Optional Lids

Protect contents from dust and damage, includes tie holes



Clear Label Holders

Accommodates labels up to 5" x 3 3/4"

Stack and Nest Containers		Outside Dimensions (In.)			Inside Dimensions (In.)			Other Specifications						
Model Number	Colours	Length	Width	Height	Length	Width	Height	Volume (Cu. Ft.)	Volume (Gal.)	Capacity (Lbs.)	Carton Quantity	Stacking Height	Lid Model	Lid Carton Quantity
35180	Standard	18	11	6	14-3/8	9-3/8	5-7/8	0.5	3.7	45	6	6	35181	6
35185	Standard	18	11	9	14-1/8	9-1/8	8-7/8	0.76	5.69	60	6	6	35181	6
35190	Standard	19-1/2	15-1/2	10	14-3/4	13-1/2	9-7/8	1.2	9	65	6	6	35191	6
35195	Standard	19-1/2	15-1/2	13	14-5/8	13-3/8	12-7/8	1.7	12.93	85	6	6	35191	6
35200	Standard	19-1/2	13-1/2	8	15-1/4	11-1/2	7-7/8	0.8	6.1	55	6	6	35201	6
35225	Standard	23-1/2	19-1/2	10	18	16-7/8	9-7/8	2	14.98	70	3	6	35231	3
35230	Standard	23-1/2	19-1/2	13	18	16-7/8	12-7/8	2.6	19.4	90	3	6	35231	3
35240	Standard	23-1/2	15-1/2	12	18-1/4	13	11-7/8	1.7	12.9	75	3	6	35241	3
35300	Standard	29-1/2	19-1/2	15	23-1/2	16-5/8	14-7/8	3.7	27.4	100	3	6	35301	3

Order in carton quantities. Other colours and customizations available upon request (minimum orders apply)

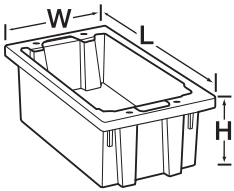
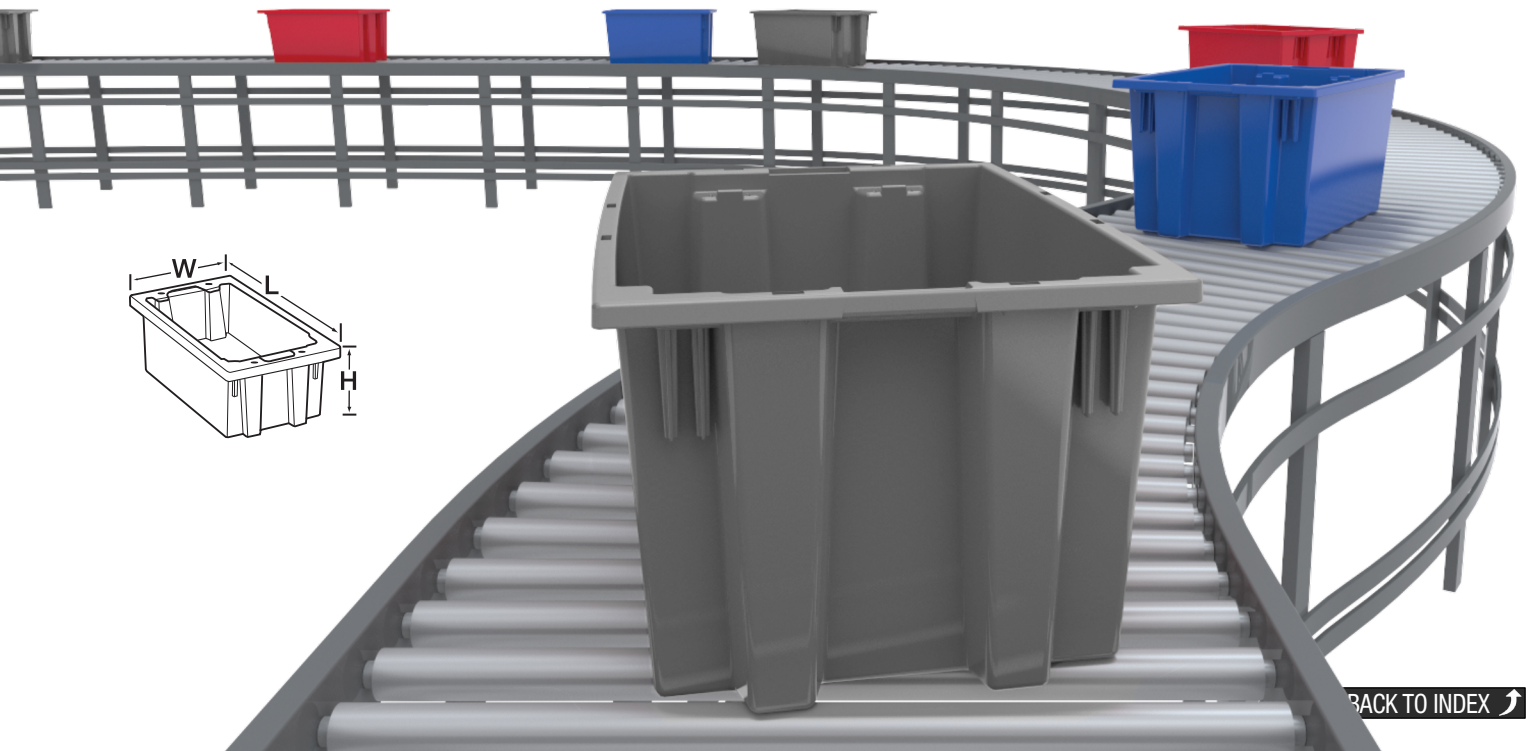

STACK AND NEST CONTAINERS

SMART, STRONG, SPACE-SAVING STORAGE

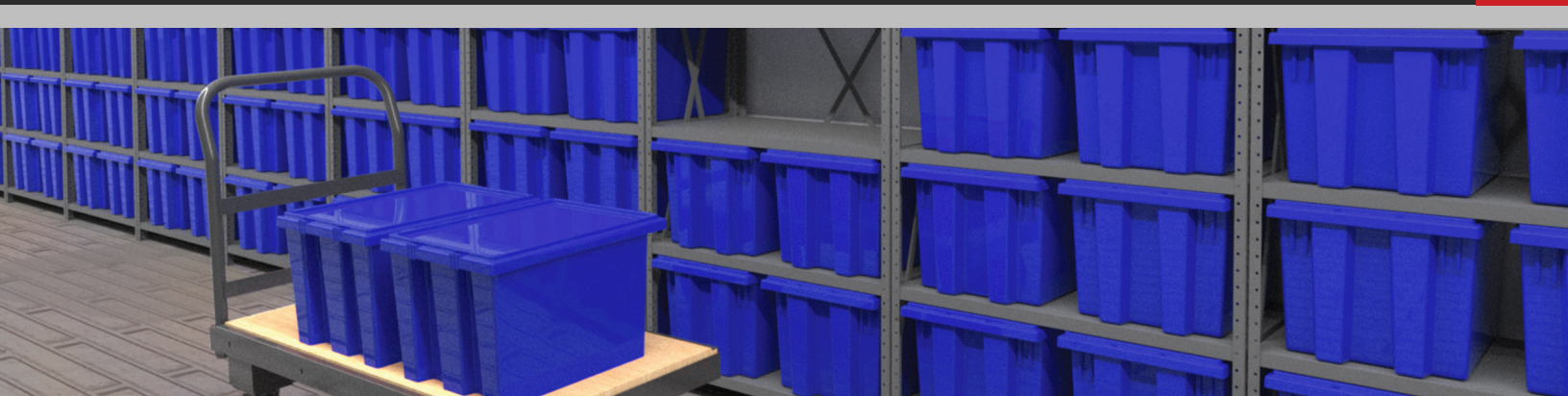

Stack and Nest Containers – Efficiency, Durability & Secure Stacking!

Keep your storage and transport streamlined with our high-performance containers! Engineered for maximum functionality, these totes provide secure stacking, easy handling, and reliable protection for your materials.

FEATURES:

- 1 **Easy-to-Clean:** Smooth finish ensures effortless maintenance.
- 2 **Ergonomic Grip:** Comfortable design makes lifting and carrying a breeze.
- 3 **Jam-Free Nesting:** Ribs under the lip prevent sticking when nested.
- 4 **Slip-Resistant Base:** Textured bottoms provide stable grip on conveyor belts.
- 5 **Stackable Without Lids:** Wide stacking ledge ensures stability for storage and shipping.
- 6 **Added Security:** Lids feature tie holes for extra protection when needed.

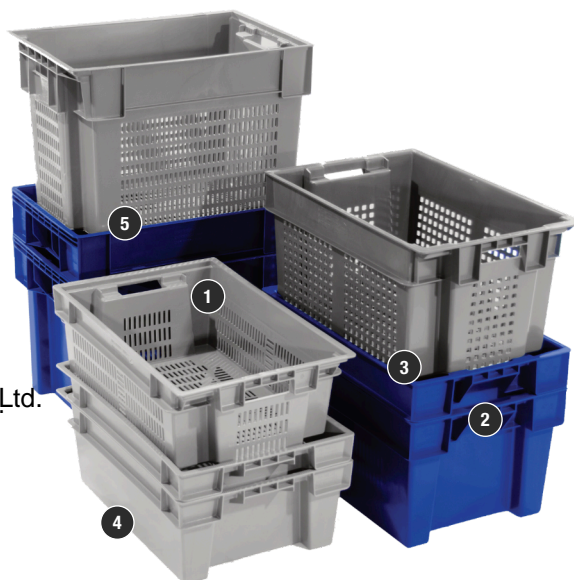

PRODUCT HIGHLIGHTS:

- **Space-Saving:** Securely stacks when full, nests when empty to optimize storage.
- **Durability:** Industrial-grade polymer resists wear, reducing replacement costs.
- **FDA-Compliant:** Safe for regulated environments and food applications.
- **Standardized:** SN2416 series totes are cross-compatible for seamless system integration.
- **Optimized for Pallets:** Fits five per layer on a standard 48" x 40" pallet, maximizing shipping efficiency.
- **Options:** Vented sides and bottom options for added airflow, cooling, or drainage.



RELATED PRODUCTS:

Create the perfect storage system - mix and match your selection of stack and nest containers with the following products.

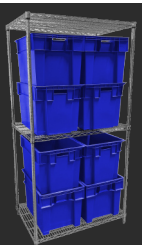

Wire Shelving Systems



Attached Lid Containers



Cross Stack and Nest Containers

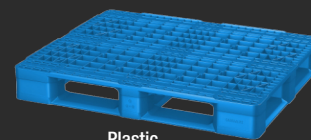

Plastic Pallets

STACK AND NEST CONTAINERS

SMART, STRONG, SPACE-SAVING STORAGE



Standard Colours



SN24160800

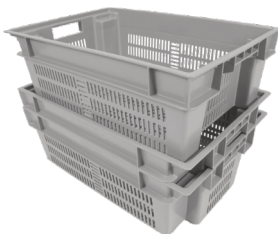

SN24160822

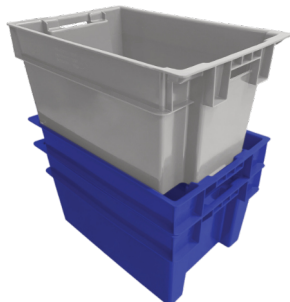

SN24161200

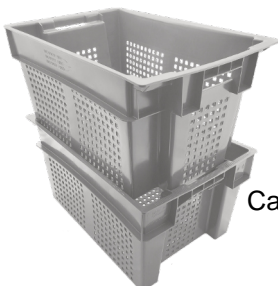

SN24161222



SN24161600

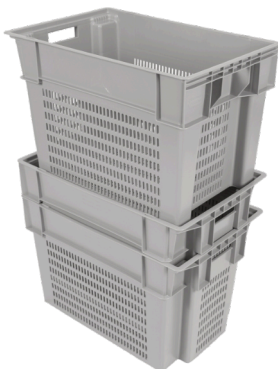

SN24161622



Caster-Rack Systems Ltd.

WIRE SHELVING KITS

Chrome vs Epoxy

Shelf kits are available in both chrome or epoxy finish. Chrome plated finish is very durable and is ideal for dry storage environments. Epoxy is the ideal solution for high humidity, wet, or walk-in-cooler applications. more economical, small footprint, easy to remove bins from rails. Specify finish when ordering.

See wire shelving for more information.

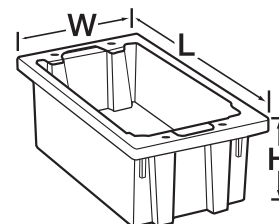

ACCESSORIES:



Lids

Protect contents from dust and damage, includes tie holes



Stack and Nest Containers		Outside Dimensions (In.)			Inside Dimensions (In.)			Other Specifications				
Model Number	Colours	Length	Width	Height	Length	Width	Height	Weight (Lbs.)	Volume (Cu. Ft.)	Capacity (Lbs.)	Stacking Height	Lid Model
SN24160800	Standard	23-1/2	15-1/2	7-7/8	18	13-1/4	7-5/8	4.00	0.97	80	6	SL24160200
SN24160822	Standard	23-1/2	15-1/2	7-7/8	18	13-1/4	7-5/8	3.20	0.97	80	6	SL24160200
SN24161200	Standard	23-1/2	15-1/2	11-3/4	18	13-1/4	11-5/8	4.80	1.57	80	6	SL24160200
SN24161222	Standard	23-1/2	15-1/2	11-3/4	18	13-1/4	11-5/8	4.40	1.57	80	6	SL24160200
SN24161600	Standard	23-1/2	15-1/2	15-5/8	18	13-1/4	15-1/2	6.60	2.09	80	6	SL24160200
SN24161622	Standard	23-1/2	15-1/2	15-5/8	18	13-1/4	15-1/2	6.10	2.09	80	6	SL24160200

Other colours and customizations available with minimum order.

STACK AND NEST CONTAINERS

SMART, STRONG, SPACE-SAVING STORAGE



Standard Colours



Stack and Nest Containers – Smart, Durable & Space-Saving!

Enhance efficiency and streamline your storage with our high-performance Stack and Nest Containers! Designed for ultimate versatility, these containers make handling, organizing, and transporting goods effortless across industries.

FEATURES:

- 1 **Space-Saving Design:** Stack when full, nest when empty to maximize storage capacity.
- 2 **Built to Last:** Engineered for durability in tough environments and heavy use.
- 3 **Ergonomic Handling:** Reinforced edges and easy-grip design ensure effortless transport.
- 4 **Versatile & Adaptable:** Ideal for manufacturing, retail, logistics, and more.
- 5 **Optimized Sorting & Transport:** Available in multiple sizes for efficient organization.

PRODUCT HIGHLIGHTS:

- **Seamless Transition:** Stack securely for storage and shipping; nest compactly when empty.
- **Long-Lasting Durability:** Industrial-grade polymer construction resists wear and tear.
- **Effortless Organization:** Designed to simplify logistics and boost workplace efficiency.

Caster-Rack Systems Ltd.

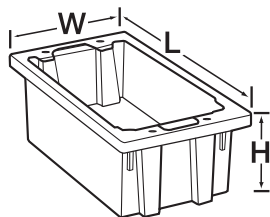

C18702



SN20161200



SN21141200



007640



007644



NS920



007641

Stack and Nest Containers		Outside Dimensions (In.)			Inside Dimensions (In.)			Other Specifications		
Model Number	Colours	Length	Width	Height	Length	Width	Height	Weight (Lbs.)	Volume (Cu. Ft.)	Capacity (Lbs.)
007640	Blue	19-1/8	19-1/8	10-5/8	15-7/16	15-7/16	10-1/2	4.00	1.37	45
007641	Orange	19-1/8	19-1/8	10-5/8	15-7/16	15-7/16	10-1/2	4.00	1.37	45
007644	Green	23-7/16	18-1/2	12-1/4	19-3/16	16-1/16	12	5.40	1.99	75
C18702	Standard	31-1/2	18-1/4	12	24-3/4	16-5/8	11-3/4	8.40	2.35	125
SN20161200	Standard	19-3/4	15-7/8	11-7/8	17-3/8	11	11-3/4	4.80	1.26	60
SN21141200	Standard	20-7/8	13-7/8	12-1/8	17	10-3/4	11-7/8	4.20	0.87	70
NS920	Blue	15-1/4	12-1/4	6	14-1/8	11-3/16	5-1/4	2.00	0.48	45

Other colours and customizations available with minimum order.



CROSS STACK AND NEST CONTAINERS

TOUGH, TIDY, BUILT TO LAST

Standard Colours



Jumbo Lug Containers – Rugged, Reliable, Ready for Anything!

Designed for the demands of shipping, storage, and distribution, our Jumbo Lug Containers are built to take on heavy-duty tasks with ease. With tough construction, nest-and-stack versatility, and FDA-compliant materials, these containers make handling more efficient in every environment.

FEATURES:

- 1 **Stackable:** Integrated grooves create secure 90° stacks with or without lids.
- 2 **Nestable:** Maximize space with compact nesting capability.
- 3 **Extra Strength:** Reinforced walls and ribs deliver exceptional load-bearing durability.
- 4 **Molded-In Handles:** Comfortable grip for smooth and easy lifting.
- 5 **Colour-Code Compatible:** Choose from multiple colours to quickly identify contents.

PRODUCT HIGHLIGHTS:

- **Durable:** Made from industrial-grade polymer that resists rust, corrosion, and splintering.
- **FDA-Compliant:** Safe for food handling and regulated environments.
- **Smooth & Sanitary:** Easy-to-clean surfaces support hygiene standards.
- **System Compatible:** Sized to fit standard 36" shelving and conveyor systems.
- **Value:** Designed for long service life, reducing replacement costs.

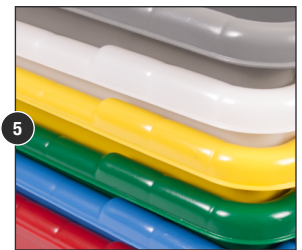

Caster-Rack Systems Ltd.

ACCESSORIES:

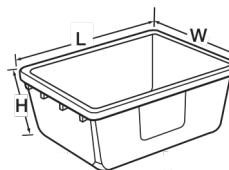

Lids

Protect bin contents from dust

Cross Stack and Nest Containers		Outside Dimensions (In.)			Inside Dimensions (In.)			Other Specifications		
Model Number	Colours	Length	Width	Height	Length	Width	Height	Volume (Cu. Ft.)	Capacity (Lbs.)	Lid Model
JL25160968	Standard	24-7/8	15-7/8	8-1/2	21	12	8-3/8	1.02	100	LJ25160200

Other colours and customizations available with minimum order.

RELATED PRODUCTS:

Create the perfect storage system - mix and match your selection of cross stack and nest containers with the following products.



Wire Shelving Systems

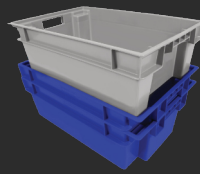

Stack and Nest Containers

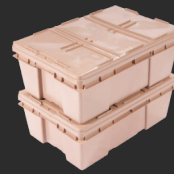

Detached Lid Containers

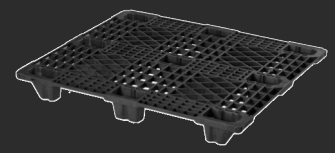

Plastic Pallets

NESTING AND COLLAPSIBLE CONTAINERS

SPACE-SAVING STORAGE SOLUTION



Standard Colours



Stack and Nest Trays – Space-Saving and Built to Last

Ideal for shipping, storage, and distribution, these versatile trays offer a rugged and efficient solution for material handling.

PRODUCT HIGHLIGHTS:

- **Efficient:** Stack space-saving storage and shipping. Empty trays nest for compact storage.
- **Vented:** Designed with airflow-enhancing vents to optimize ventilation and cooling.
- **Durable:** Made from strong, industrial-grade polymer that won't rust, corrode, or splinter.
- **Cost-Saving:** Long service life helps minimize replacement costs over time.
- **Safe:** Manufactured using FDA-approved materials for safe use with food or sensitive goods.

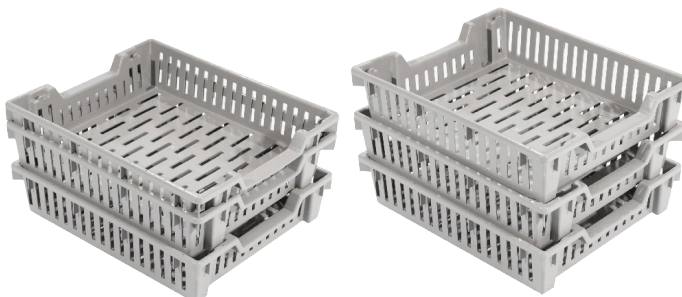

AG20160422

AG20160522



AG19140522

Stack and Nest Trays		Outside Dimensions (In.)			Inside Dimensions (In.)			Other Specifications		
Model Number	Colours	Length	Width	Height	Length	Width	Height	Weight (Lbs.)	Capacity (Lbs.)	Pallet Quantity
AG191405	Grey	18-3/4	13-5/8	4-9/16	16-1/2	12-1/2	4	1.63	20	348
AG201604	Grey	19-1/2	16-3/8	4-3/16	16-5/8	14-5/8	3-1/2	1.68	20	340
AG201605	Grey	19-1/2	16-3/8	5	16-11/16	14-5/8	4-1/2	1.72	20	300

Other colours and customizations available with minimum order.

Collapsible Crates – Smart, Space-Saving Storage

Quick-folding crates designed for modern logistics. Save space, simplify handling, and keep goods secure in automated systems.

PRODUCT HIGHLIGHTS:

- **Collapsible:** Easy to collapse for space and return shipping savings.
- **Ergonomic:** Comfortable grip for easy handling.
- **Locking System:** Advanced models feature secure, easy-to-use locks.
- **Cross-Stacking:** Stable stacking keeps goods protected.
- **Modular:** Mix and match crate sizes maximize space utilization.

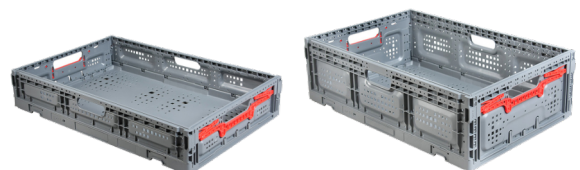

PFV6411

PFV6418

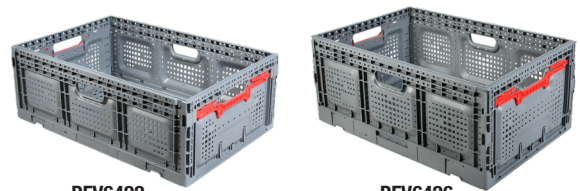

PFV6422

PFV6426



Collapsible Crates		Outside Dimensions (In.)			Inside Dimensions (In.)			Other Specifications		
Model Number	Colours	Length	Width	Height	Length	Width	Height	Weight (Lbs.)	Capacity (Lbs.)	Pallet Quantity
PFV6411	Standard	23-5/8	15-3/4	4-1/2	22-5/8	14-7/8	4-1/8	2.97	22	425
PFV6418	Standard	23-5/8	15-3/4	7-1/4	22-5/8	14-7/8	6-7/8	3.79	40	425
PFV6422	Standard	23-5/8	15-3/4	8-5/8	22-5/8	14-7/8	8-1/4	4.01	44	425
PFV6426	Standard	23-5/8	15-3/4	10-3/16	22-5/8	14-7/8	9-7/8	4.89	44	240

Other colours and customizations available with minimum order.



MULTI-PURPOSE TRAYS

VERSATILE, MAXIMIZE AIRFLOW, OPTIMIZED FOR TRANSPORT

Standard Colours



Multi-Purpose Trays – Versatile, Space-Saving

Streamline storage, transport, and product access with Multi-Purpose Trays, designed to provide durable performance in demanding environments. Their intuitive design maximizes airflow, stacking efficiency, and mobility.

FEATURES:

- 1 **Secure Stackability:** Tongue-and-groove design keeps trays firmly in place during transport.
- 2 **Effortless Access:** Low-profile sidewalls make contents easy to reach.
- 3 **Optimized Ventilation:** Open-grid base and sides promote airflow.
- 4 **Space Efficiency:** Trays stack and nest within their own footprints to minimize storage waste and back haul volume.
- 5 **Durable:** Corrosion-resistant, splinter-free, and 100% recyclable.

PRODUCT HIGHLIGHTS:

- **Mobility Ready:** Pair with dollies for hassle-free transport.
- **Efficiency:** Allows full cube loading, reducing shipping costs.
- **Versatile:** Designed for distribution, agriculture, storage and more.
- **Sustainable:** Eco-conscious without sacrificing durability.
- **Durable:** Withstands rugged use and extreme temperatures.

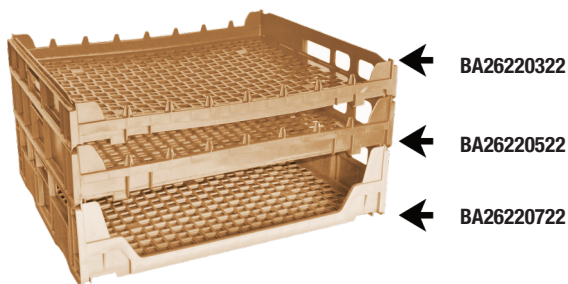

Multi-Purpose Trays		Outside Dimensions (In.)			Inside Dimensions (In.)			Other Specifications	
Model Number	Colour	Length	Width	Height	Length	Width	Height	Weight (Lbs.)	Capacity (Lbs.)
BA23200422	Red	22-3/4	20-1/8	3-5/8	21-7/8	19-3/8	3-1/8	2.2	10
BA26220322	Standard	25-7/8	21-5/8	3-3/8	24-5/8	20-5/8	2-11/16	2.8	10
BA26220522	Standard	26	21-3/4	4-1/2	24-5/8	20-5/8	3-7/8	2.8	10
BA26220622	Standard	26-3/4	22-1/8	5-3/4	25-7/16	21-1/8	5	3.4	18
BA26220722	Standard	25-3/4	21-3/4	6-1/2	24-3/4	20-7/8	5-3/4	4	20
BL27230623	Standard	27-1/2	23-5/8	6-1/2	24-3/4	22-1/2	5-3/4	5.8	20
BA29260684	Standard	29	26	6-1/10	27-4/5	24-4/5	5-3/10	5.4	20
BT28220522	Blue	28-3/10	22	4-4/5	25	20-2/5	3-7/10	3.9	30
BT28220722	Red	28-3/10	22	6-4/5	24-4/5	20-1/5	5-7/10	4.6	30
CT29260922	Standard	29-1/10	26-1/10	9	27-4/5	24-7/10	7-1/2	6.90	80

Other colours and customizations available with minimum order.

DETACHED LID CONTAINERS

SECURE, VERSATILE, EFFICIENT SHIPPING AND STORAGE



Standard Colours



Detached Lid Containers – Secure, Stackable, Versatile

Optimized for shipping, storage, and handling—these rugged containers feature removable lids, nestable design, and ergonomic construction.

FEATURES:

- 1 **Stack & Nest Design:** Containers stack firmly with lids and nest when empty.
- 2 **Snap-Tight Lids:** Secure closure for clean, protected transport.
- 3 **Shipping Tie Ready:** Reinforced holes fit multiple security ties.
- 4 **Ergonomic Handling:** Comfortable molded handles for easy lifting.
- 5 **Weather-Resistant:** Safe for use in temperatures from -20° to 120° F.
- 6 **Durable:** High-capacity build helps prevent product damage.
- 7 **Multiple Footprints:** DL Series: 21"×15" and 24"×20"; NestPack cross-stacks 5 per layer on 48"×40" pallet.

PRODUCT HIGHLIGHTS:

- **Space-Efficient:** Nestable and stackable to reduce return costs.
- **Secure:** Lids and tie holes ensure safe shipping.
- **Durable:** Withstands repeated use and rough handling.
- **Customizable:** Identification and labeling options available.
- **Application:** NestPack Ideal for meat and poultry.

ACCESSORIES:



Lids

Protect contents from dust and damage, includes tie holes

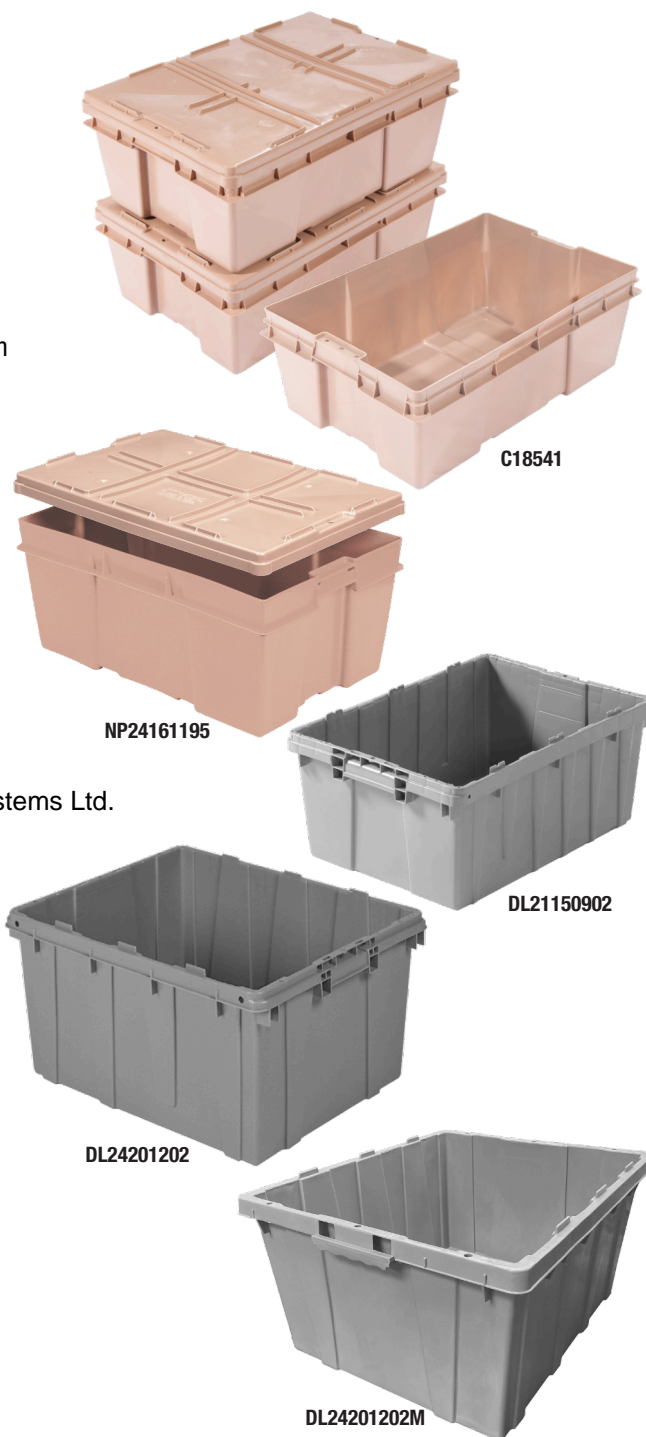

Detached Lid Containers		Outside Dimensions (In.)			Inside Dimensions (In.)			Other Specifications			
Model Number	Colours	Length	Width	Height	Length	Width	Height	Weight (Lbs.)	Volume (Cu. Ft.)	Capacity (Lbs.)	Lid Model
C18541	Beige	23-5/8	15-5/8	8-3/4	20-1/4	13-1/4	8-5/8	4.28	1.2	50	C18525
NP24161195	Beige	24-3/10	16-3/10	10-9/10	20-1/10	13-3/10	10-2/5	5.5	1.6	80	C18525
DL21150902	Standard	21-2/5	15-3/10	9-3/5	18-2/5	13	9	3.4	1.2	60	DR21150100
DL24201202	Standard	24-1/5	20	12-2/5	20-1/2	16-3/5	11	5.5	2.4	100	DR24200100
DL24201202M	Standard	24-1/5	20	12-2/5	20-1/2	16-3/5	11	5.3	2.4	100	DR24200102M

Other colours and customizations available with minimum order.



NESTING CONTAINERS

NESTABLE, DURABLE, SPACE-SAVING

Standard Colours



Field Harvesting Baskets – Nestable, Food-Safe

Designed for produce handling and order picking, these baskets offer a durable, hygienic solution for harvesting tomatoes, fruits, and vegetables. Whether in the field or in storage, they deliver performance and convenience every time.

PRODUCT HIGHLIGHTS:

- **Versatile:** Ideal for harvesting and order picking across a range of produce types.
- **Options:** Available with solid or vented sides to suit different handling needs.
- **Safe:** Manufactured with FDA-approved materials for direct food contact.
- **Space-Saving:** Nest when empty to reduce storage volume and backhaul costs.
- **Durable:** Will not rust, corrode, or splinter.



007670GREEN



007671GREEN



007678RED

Field Harvesting Baskets			Outside Dimensions (In.)			Other Specifications	
Model Number	Colours	Style	Length	Width	Height	Weight (Lbs.)	Capacity (Lbs.)
007670	Standard	Vented	15	15	13	2.00	40
007671	Standard	Solid	15	15	13	2.20	40
007678	Red	Vented	12	12	13	1.82	35

Other colours and customizations available with minimum order.

Standard Colours



075618



075611

General Purpose Containers – Ergonomic, Durable, and Space-Saving

Perfect for order picking, work-in-process, or general storage, these containers offer a reliable and efficient solution for everyday material handling. Built for comfort and longevity, they're ready to perform wherever you need them.

PRODUCT HIGHLIGHTS:

- **Multi-Use:** Ideal for picking, processing, and storing a wide range of items.
- **Ergonomic:** Designed with comfortable handles for easy lifting and transport.
- **Durable:** Made from tough materials that won't rust, corrode, or splinter.
- **Compact:** Nestable when empty to save valuable storage space.
- **Stackable:** Model 075611 features cross-stacking capability for added versatility.

General Purpose Containers		Outside Dimensions (In.)			Inside Dimensions (In.)			Other Specifications	
Model Number	Colours	Length	Width	Height	Length	Width	Height	Weight (Lbs.)	Capacity (Lbs.)
075611	Standard	20-7/8	15-3/4	12	16-3/4	11-7/8	11-1/2	3.80	40
075618	Standard	24-3/8	17-1/5	13-3/8	20-3/4	13-7/8	12-7/8	4.60	50

Other colours and customizations available with minimum order.

ATTACHED LID CONTAINERS

SECURE, STACKABLE, EFFICIENT SHIPPING AND STORAGE



Attached Lid Containers – Strong, Secure & Ready for the Long Haul

Engineered for rugged performance, our Attached Lid Containers are ideal for shipping, storage, distribution, and order picking. These versatile containers stack, nest, and lock down with ease—delivering smart functionality and security for demanding environments.

PRODUCT HIGHLIGHTS:

- 1 **Textured Base:** Textured bottoms provide reliable traction on conveyor belts. Optional smooth base is available on select models with a minimum order.
- 2 **Ergonomic Design:** Molded-in handle grips offer control during lifting.
- 3 **Enhanced Security:** Padlock eye on both ends supports tamper-evident security ties.
- 4 **Built to Last:** Reinforced hinge pins ensure smooth, durable lid operation over time.



PRODUCT HIGHLIGHTS:

- Reusable & Functional:** Ideal for shipping, storage, and order picking.
- Secure Protection:** Lids snap shut to keep contents safe from dust and damage.
- Stackable and Nestable:** Stack with lids closed, nest with lids open to save space.
- Pallet-Ready:** Interwork effortlessly for neat, stable pallet loading.
- Variety:** Available in a many sizes and colours to fit your requirements.



For added security during transport or storage, use tote snaps or zip-ties.

RELATED PRODUCTS:

Create the perfect storage system - mix and match your selection of attached lid containers with the following products.



Detached Lid Containers

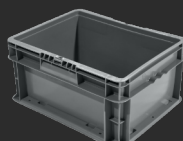

Straight Wall Containers



Stack and Nest Containers

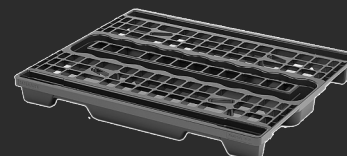

Plastic Pallets

ATTACHED LID CONTAINERS

SECURE, STACKABLE, EFFICIENT SHIPPING AND STORAGE

Standard Colours

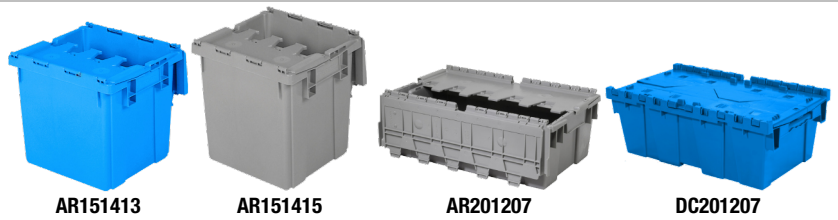

AR151413

AR151415

AR201207

DC201207

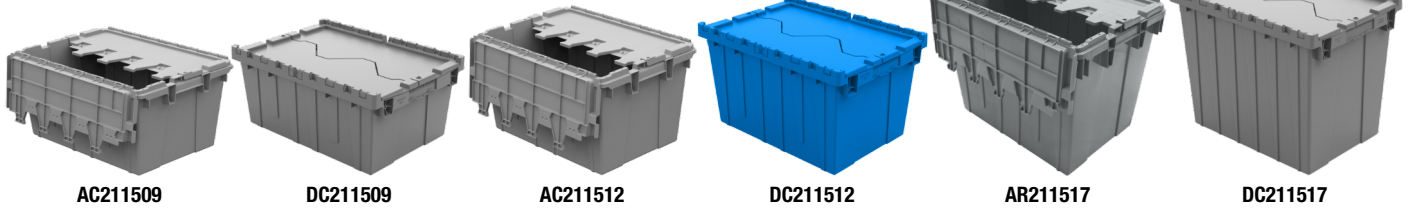

AC211509

DC211509

AC211512

DC211512

AR211517

DC211517



AR242012

DC242012

AR271709

AR271712

DC271712



AS282115

DC282015

AS342015

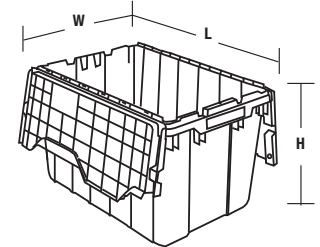

Caster-Rack Systems Ltd.

Attached Lid Containers		Outside Dimensions (In.)			Inside Dimensions (In.)			Other Specifications		
Model Number	Colours	Length	Width	Height	Length	Width	Height	Weight (Lbs.)	Volume (Cu. Ft.)	Capacity (Lbs.)
AR151413	Blue, Grey	14-3/4	13-1/2	13-3/5	11-7/16	11-3/8	12-3/5	4.60	0.9	50
AR151415	Blue, Grey	14-3/4	13-1/2	15-1/10	11-1/4	11-1/4	14-1/2	5.20	1.0	50
AR201207	Standard	20	11-7/10	7-1/2	16-9/10	9-3/5	6-1/10	3.80	0.6	40
DC201207	Blue, Green, Grey	19-3/5	11-3/5	7-3/10	16-1/2	8-7/10	6-1/5	3.10	0.5	40
AC211509	Standard	21-4/5	15-1/10	9-3/5	18-2/5	13	8-1/10	5.20	1.1	60
DC211509	Blue, Green, Grey, Red	21-9/10	15-3/10	9-3/4	18-9/10	12	8-1/5	4.70	1.3	60
AC211512	Standard	21-4/5	15-1/5	12-1/2	17-9/10	12-1/2	11-1/10	5.60	1.4	60
DC211512	Blue, Black, Green, Grey, Red, Yellow	21-9/10	15-1/5	12-4/5	18	12-1/5	11	5.40	1.7	60
AR211517	Standard	21-4/5	15-3/10	17	17-9/10	12-1/2	15-9/10	6.90	2.1	60
DC211517	Blue, Grey	21-9/10	15-1/5	17-1/5	18-2/5	12-4/5	15-4/5	7.70	2.3	60
AR242012	Standard	24	19-1/2	12-3/5	20-1/2	16-3/5	10-4/5	8.10	2.3	80
DC242012	Blue, Grey	23-4/5	19-1/5	12-1/2	20-1/2	16-1/2	11	7.70	2.4	80
AR271709	Blue, Green, Grey, Red	26-3/4	17	9-3/5	23-9/10	14-1/4	8-9/10	7.40	1.6	80
AR271712	Standard	27	16-9/10	12-1/2	23-1/2	13-4/5	10-9/10	8.20	2.3	100
DC271712	Blue, Green, Grey, Red	27-3/10	17-1/5	12-3/5	23-7/10	13-9/10	11	7.70	2.5	100
AS282115	Standard	28	20-4/5	15-2/5	25	18	14	12.60	3.6	100
DC282015	Blue, Grey	28-1/10	20-4/5	15-3/5	25	18	14	13.20	3.8	100
AS342015	Standard	34	24	19-3/5	29-9/10	19-1/2	18-1/10	19.00	6.1	100

Other colours, sizes, and customizations available with minimum order.

ATTACHED LID CONTAINERS

SECURE, STACKABLE, EFFICIENT SHIPPING AND STORAGE



Standard Colours



39085



39120



39170

General Purpose Attached Lid Containers		Outside Dimensions (In.)			Inside Dimensions (In.)			Other Specifications			
Model Number	Colours	Length	Width	Height	Length	Width	Height	Weight (Lbs.)	Volume (Cu. Ft.)	Capacity Z(Lbs.)	Carton Quantity
39085	Blue, Grey	21-1/2	15-1/4	9	18-7/16	12-7/8	7-5/8	6.20	1.12	35	6
39120	Blue, Green, Grey, Red	21-1/2	15-1/4	12-1/2	17-7/8	12-3/8	12	6.67	1.62	65	6
39170	Blue, Grey	21-1/2	15-1/4	17	17-7/8	12-3/8	15-3/4	9.00	2.28	100	3

Order in carton quantities. Other colours and customizations available upon request (minimum orders apply)

Clear Attached Lid Containers – Transparent and Secure

Simplify your storage with Clear Attached Lid Containers, designed for easy access, reliable protection, and enhanced visibility. Perfect for light to medium-duty use, these containers let you monitor contents at a glance while keeping everything securely contained.

FEATURES:

- Clear Visibility:** Transparent sides offer quick identification of contents without opening the lid.
- Integrated Lid:** Attached lids ensure nothing gets misplaced.
- Enhanced Security:** Padlock eye on both ends accepts security ties for added peace of mind.
- Durable Hinges:** Reinforced hinge pins ensure smooth, long-lasting lid operation.
- Specialty Storage:** Hanging File KeepBox includes metal rails for easy organization of letter-size folders.

Caster-Rack Systems Ltd.

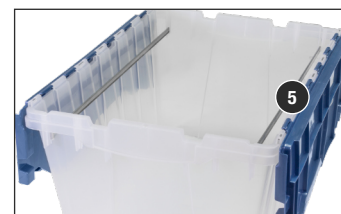
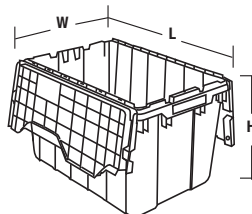

PRODUCT HIGHLIGHTS:

- Functional:** Provides clean, dust-free storage and reliable protection during transport.
- Nestable:** Efficiently nests when empty to save space in storage areas.



39120



66486CLDBL



66486FILEB



66497CLDGN

Clear Attached Lid Containers		Outside Dimensions (In.)			Inside Dimensions (In.)			Other Specifications			
Model Number	Colours	Length	Width	Height	Length	Width	Height	Weight (Lbs.)	Volume (Cu. Ft.)	Capacity (Lbs.)	Carton Quantity
66486CLDBL	Standard	21-1/2	15-1/4	12-1/2	17-7/8	12-3/4	12	5.50	1.6	25	6
66486FILEB	Standard	21-1/2	15-1/4	12-1/2	17-7/8	12-3/4	12	5.50	1.6	25	6
66497CLDGN	Standard	21-1/2	15-1/4	17	17-7/8	12-3/4	15-3/4	9.00	2.3	35	3
39120CLEAR	Standard	21-1/2	15-1/4	12-1/2	17-7/8	12-3/8	12	6.67	1.62	65	6

Order in carton quantities.

STRAIGHT WALL CONTAINERS

INDUSTRIAL REUSABLE CONTAINERS



Straight Wall Containers – Stack-Only, Supply Chain Ready

Built for closed-loop shipping and in-process handling, Straight Wall Containers offer streamlined durability, protective stacking, and pallet-ready compatibility.

FEATURES:

- 1 **Bottom Style:** Smooth or reinforced cross-cube bottom designs available.
- 2 **Pallet Fit:** Containers cube precisely to industry standard pallets.
- 3 **Reinforced Structure:** Reinforced sides and bottoms enhance protection during handling.
- 4 **Interstacking:** Interworking sizes allow mixed stacking on a single pallet.
- 5 **Compatibility:** Compatible with other brands to expand your existing system.
- 6 **Ergonomic Handles:** Designed to distribute load evenly across four fingers.
- 7 **Label Areas:** Textured label areas available on up to four sides for quick identification.
- 8 **Material:** Injection-molded HDPE resists impact, moisture, and most chemicals.
- 9 **Temperature Range:** Use in conditions from -20° to 120° F without compromising integrity.



PRODUCT HIGHLIGHTS:

- **Functional:** Optimized for stacked efficiency in shipping, and storage.
- **Durable:** Built tough for industrial workflows with reinforced sidewalls.
- **Compatible:** Mix and integrate with pallet and container systems.
- **Ergonomic:** Easy to lift, label, and maintain—even when gloved.
- **Sustainable:** Recyclable and reusable across long-term operations.

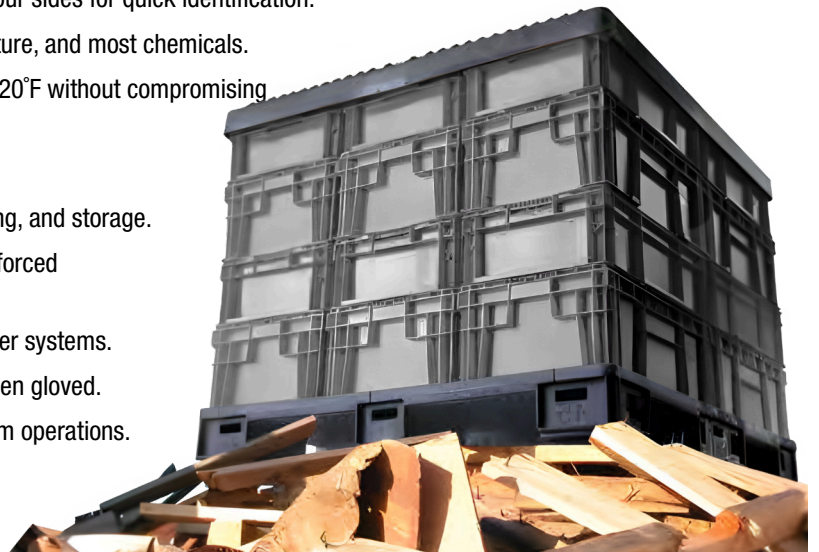

RELATED PRODUCTS:

Create the perfect storage system - mix and match your selection of straight wall containers with the following products.



Attached Lid Containers



Detached Lid Containers



Stack and Nest Containers

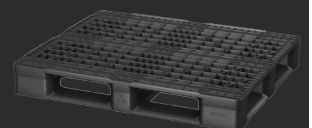

Plastic Pallets

STRAIGHT WALL CONTAINERS

INDUSTRIAL REUSABLE CONTAINERS



Standard Colours



ACCESSORIES:



Lids
Protect bin contents from dust



SW120705F1



SW151205F1



SW151207F1



SW151209F1



SW241504A2



SW241505F1



SW241507F1



SW241509F1



SW241511F1



SW241514F1



SW242211F1



SW242214F1

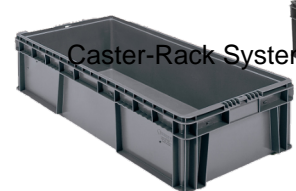

SW32150802



SW48150802

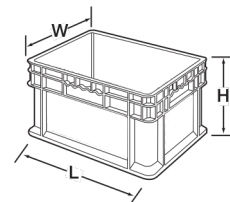

Caster-Rack Systems Ltd.

Straight Wall Containers		Outside Dimensions (In.)			Inside Dimensions (In.)			Other Specifications		
Model Number	Colours	Length	Width	Height	Length	Width	Height	Weight (Lbs.)	Volume (Cu. Ft.)	Lid Model
SW120705F1	Standard	12	7	5	9-1/2	5-3/5	4-2/5	1.1	0.1	-
SW151205F1	Standard	15	12	5	13-1/10	9-1/2	4-2/5	1.8	0.3	SL15120100
SW15120602	Standard	15	12	5-1/2	13	9-2/5	4-4/5	2.3	0.31	SL15120100
SW151207F1	Standard	15	12	7-1/2	13-1/10	9-1/2	6-9/10	2.4	0.5	SL15120100
SW151209F1	Standard	15	12	9-1/2	13-1/10	9-1/2	8-9/10	2.7	0.6	SL15120100
SW241504A2	Standard	24	15	4	21-2/5	13	3-3/10	2.9	0.5	SL24150100
SW241505F1	Standard	24	15	5	21-1/2	13-1/10	4-2/5	2.9	0.7	SL24150100
SW24150602	Standard	24	15	5-1/2	21-2/5	13	4-4/5	3.7	0.8	SL24150100
SW241507F1	Standard	24	15	7-1/2	21-1/2	13-1/10	6-9/10	3.7	1.1	SL24150100
SW241509F1	Standard	24	15	9-1/2	21-1/2	13-1/10	8-9/10	4.2	1.5	SL24150100
SW241511F1	Standard	24	15	11	21-1/2	13-1/10	10-2/5	4.7	1.7	SL24150100
SW241514F1	Standard	24	15	14-1/2	21-1/2	13-1/10	13-9/10	5.8	2.3	SL24150100
SW242207F1	Standard	24	22-1/2	7-1/2	21-1/2	20-3/5	6-9/10	4.9	1.8	*
SW242209F1	Standard	24	22-1/2	8-7/10	21-1/2	20-3/5	8-1/10	5.3	2.1	*
SW242211F1	Standard	24	22-1/2	11	21-1/2	20-3/5	10-2/5	6	2.7	*
SW242214F1	Standard	24	22-1/2	14-1/2	21-1/2	20-3/5	13-9/10	7.6	3.6	*
SW32150802	Standard	32	15	7-1/2	29-2/5	13	6-4/5	5.1	1.5	*
SW48150802	Standard	48	15	7-1/2	45-2/5	13	6-4/5	7.5	2.4	*

Other colours and customizations available with minimum order. *Lids available, non-stock, minimum orders apply.



STRAIGHT WALL CONTAINERS

INDUSTRIAL REUSABLE CONTAINERS

Standard Colours

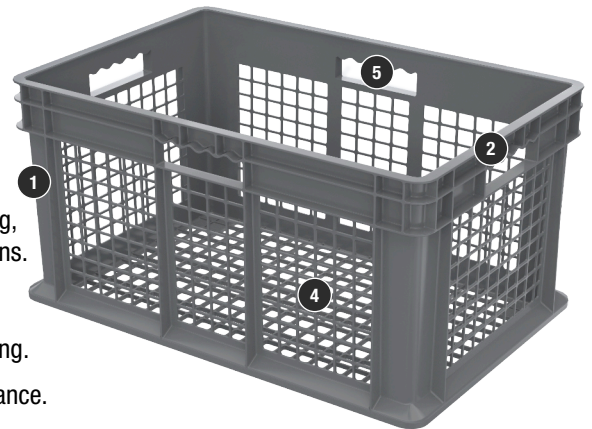

Straight Wall Containers – Durable, Built for the Supply Chain

Purpose-built for material handling, these reusable containers offer secure stacking, ventilation, and ergonomic access for transport, storage, and in-process applications.

FEATURES:

- 1 **Wall Thickness:** 1" thick walls deliver sturdy load support and reliable stacking.
- 2 **Strength:** Reinforced 1" stacking rims and external ribbing add impact resistance.
- 3 **Efficient Cubing:** Straight wall design maximizes space on pallets and in trailers.
- 4 **Mesh Pattern:** Open .72" x .90" mesh enhances airflow and visibility.
- 5 **Ergonomic Access:** Large handles on all four sides ensure a safe and comfortable grip.

PRODUCT HIGHLIGHTS:

- **Functional:** Ideal for reuse in shipping, storage, and manufacturing workflows.
- **Solid:** Smooth interior walls allow easy cleaning and meet sanitary standards.
- **Mesh:** Ventilated structure promotes air circulation and proper drainage.
- **Durable:** Made from injection-molded polymers for lasting performance.
- **Variety:** Available in multiple configurations to suit various applications.



Castle Rack Systems Ltd.

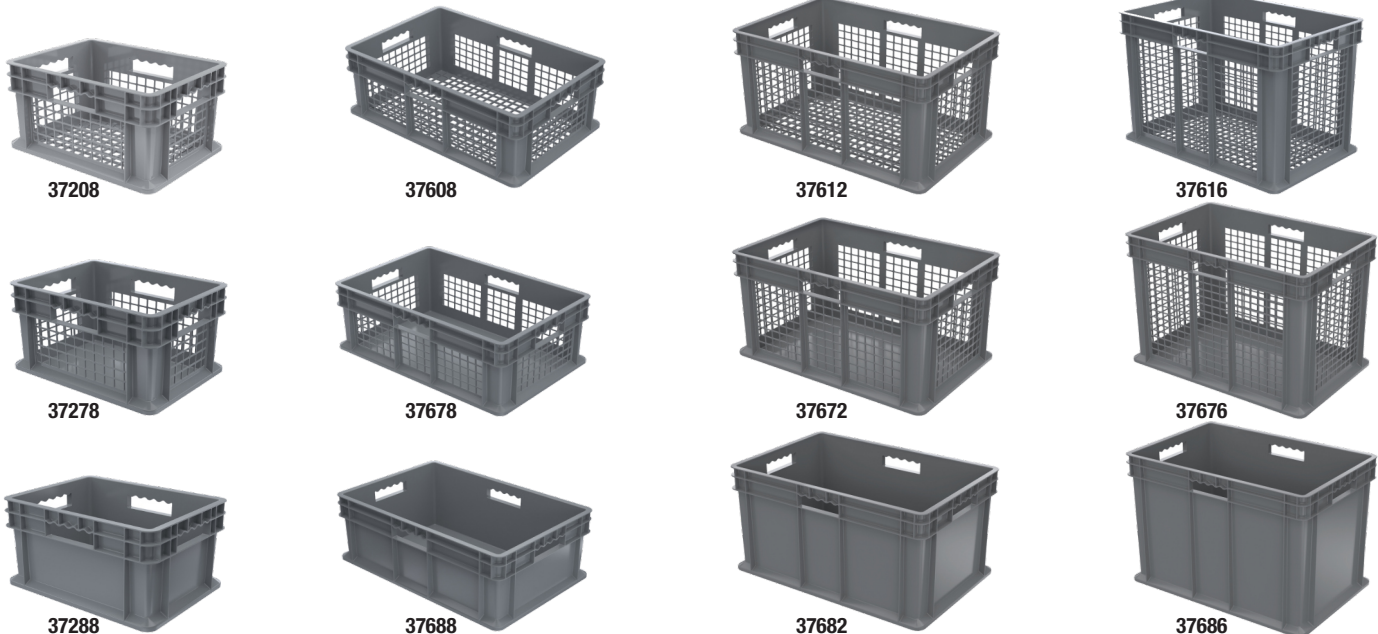

Straight Wall Containers			Outside Top Dimensions (In.)			Inside Dimensions (In.)			Other Specifications			Stacked Capacity/Quantity	
Model Number Mesh Side & Base	Model Number Mesh Side/Solid Base	Model Number Solid Side & Base	Length	Width	Height	Length	Width	Height	Volume (Cu. Ft.)	Volume (Gal.)	Carton Quantity	Solid Bottom	Mesh Bottom
37208	37278	37288	15-3/4	11-3/4	8-1/4	14	10	8	0.89	5.12	12	83 lbs./6	30 lbs./6
37608	37678	37688	23-3/4	15-3/4	8-1/4	22	14	8	1.78	11.19	4	83 lbs./6	45 lbs./6
37612	37672	37682	23-3/4	15-3/4	12-1/4	22	14	12	2.67	8.32	3	125 lbs./5	45 lbs./5
37616	37676	37686	23-3/4	15-3/4	16-1/8	22	14	16	3.55	11.07	2	150 lbs./4	45 lbs./4

Order in carton quantities. Other colours and customizations available upon request (minimum orders apply).

GRID CONTAINERS

CUSTOMIZABLE DIVIDABLE CONTAINERS



Standard Colours

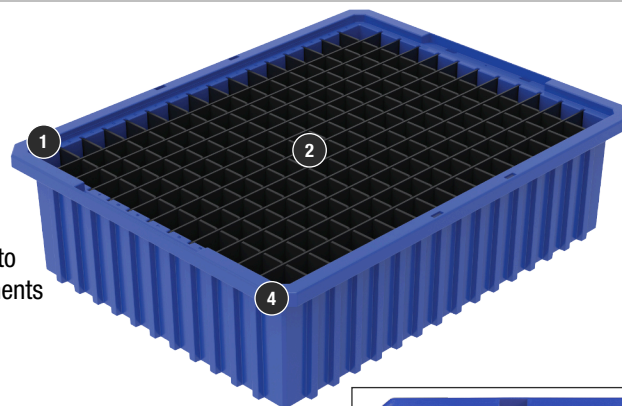

Grid Containers – Flexible Storage That Works Your Way

Get total control over your parts organization with our highly adaptable Grid Containers. Designed for precision and durability, these containers allow you to customize compartment layouts, making them ideal for sorting small components in any workspace.

FEATURES:

- 1 Modular Layouts:** Built-in divider slots let you create unique compartment configurations.
- 2 Precision Sorting:** Optional dividers (sold separately) subdivide into 1-1/8" square compartments for detailed organization.
- 3 Easy Tracking:** Molded-in letter/number system simplifies parts identification.
- 4 Built to Stack:** Reinforced stacking rims and external ribbing add strength and stability.



PRODUCT HIGHLIGHTS:

- **Versatile:** Compatible with most racks, shelving, and automated storage and retrieval systems.
- **Strength:** Injection-molded from industrial-grade polymers, resistant to most chemicals and solvents.
- **Durability:** Long service life lowers replacement frequency and overall costs.
- **Variety:** Available in a wide range of sizes.

ACCESSORIES:



Lids
Protect bin contents from dust



Label Holders
Snap securely on any side of the container (except 33162, 33164, 33223, 33224)

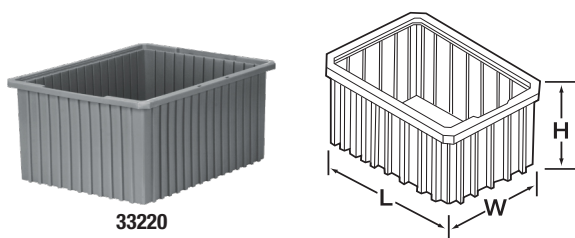

Grid Accessories	Outside Dimensions (In.)			Other Specifications	
Model Number	Length	Width	Height	Compatibility	Carton Quantity
33011	11-1/2	8-11/16	15/16	33105	10
33061	17-3/16	11-5/16	15/16	33162, 33164, 33166, 33168	4
33023	23-5/16	18-1/16	15/16	33220, 33222, 33223, 33224, 33226, 33228	3
35010	-	5	3-3/4	Fits all except 33162, 33164, 33223, 33224	6

Grid Containers		Outside Top Dimensions (In.)			Inside Dimensions (In.)			Other Specifications				Accessories		
Model Number	Colours	Length	Width	Height	Length	Width	Height	Volume (Cu. Ft.)	Volume (Gal.)	Capacity (Lbs.)	Carton Quantity	Long Divider*	Short Divider*	Package Quantity
33105	Standard	10-7/8	8-1/4	5	9-1/8	6-1/2	4-5/8	.16	1.2	25	20	42105 (5)	41105 (7)	6
33162	Red	16-1/2	10-7/8	2-1/2	14-3/4	9-1/8	2-3/8	0.20	1.5	20	12	42162 (7)	-	6
33164	Standard	16-1/2	10-7/8	4	14-13/16	9-3/16	3-7/8	0.29	2.2	20	12	42164 (7)	41164 (11)	6
33165	Red	16-1/2	10-7/8	5	14-5/8	9	4-7/8	0.39	2.9	35	12	42165 (7)	-	6
33166	Standard	16-1/2	10-7/8	6	14-3/4	9-1/8	5-9/16	0.44	3.3	35	8	42166 (7)	41166 (11)	6
33168	Standard	16-1/2	10-7/8	8	14-5/8	9-1/16	7-9/16	0.59	4.4	40	6	42168 (7)	41168 (11)	6
33220	Standard	22-3/8	17-3/8	10	19-7/8	14-7/8	9-7/8	1.66	12.4	50	2	42220 (11)	41220 (15)	6
33222	Standard	22-1/2	17-1/2	12	19-15/16	14-15/16	11-13/16	2.10	15.9	60	3	42222 (11)	-	6
33223	Standard	22-1/2	17-3/8	3	20-7/16	15-3/8	2-1/2	0.47	3.5	30	6	42223 (11)	41223 (15)	6
33224	Standard	22-3/8	17-3/8	4	20	15	3-7/8	0.61	4.6	30	6	42224 (11)	41224 (15)	6
33226	Standard	22-3/8	17-3/8	6	19-7/8	14-7/8	5-7/8	0.96	7.2	40	4	42226 (11)	41226 (15)	6
33228	Standard	22-3/8	17-3/8	8	19-7/8	14-7/8	7-7/16	1.30	9.7	50	3	42228 (11)	41228 (15)	6

Order in carton quantities. Other colours and customizations available upon request (minimum orders apply). *() = max # of dividers.



PLASTIC PALLETS

HEAVY-DUTY, REUSABLE, SUSTAINABLE

Standard Colours



Plastic Pallets - Reusable, Recyclable, Durable

Our range of plastic pallets offer durable, sustainable, and cost-effective solutions for material handling, storage, and transport. Whether you need nestable pallets for space-saving, racking models for high-bay storage, or hybrid designs that combine both, each pallet is built for performance and longevity.

FEATURES:

Nestable Export Plastic Pallet – PP107 Series:

- 1 **Design:** Space-saving nesting ratio up to 4:1.
- 2 **Durability:** Resistant to rot, mildew, and splintering.
- 3 **Handling:** Extremely lightweight for easy and safe handling.
- 4 **Efficiency:** Cost-effective return freight and storage.

Nest-Rack Pallet – NRUS5 Series:

- 1 **Design:** Runners ensure smooth movement on conveyors.
- 2 **Durability:** Outstanding weight-to-load ratio.
- 3 **Handling:** Nestable for space-saving storage.
- 4 **Efficiency:** 4-way forklift access for operational flexibility.

Rackable, Stackable Pallet – ECOUS5 Series:

- 1 **Design:** Optimized for high rack compatibility.
- 2 **Durability:** Long service life due to reinforced structure.
- 3 **Handling:** Industry standard design for broad application.
- 4 **Efficiency:** Reusable across multiple logistics cycles, stable stacking for efficient storage and transport.

PRODUCT HIGHLIGHTS:

- **Sustainable:** All pallets are made from recycled plastic and are 100% recyclable (virgin blue options available in select models).
- **Robust:** Designed for durability, reusability, and operational efficiency.
- **Space Saving:** Nestable options offer excellent space-saving benefits.
- **Rackable Options:** Racking models provide secure high-rack storage and conveyor compatibility.
- **Variety:** Open deck and closed deck surfaces available in each model.

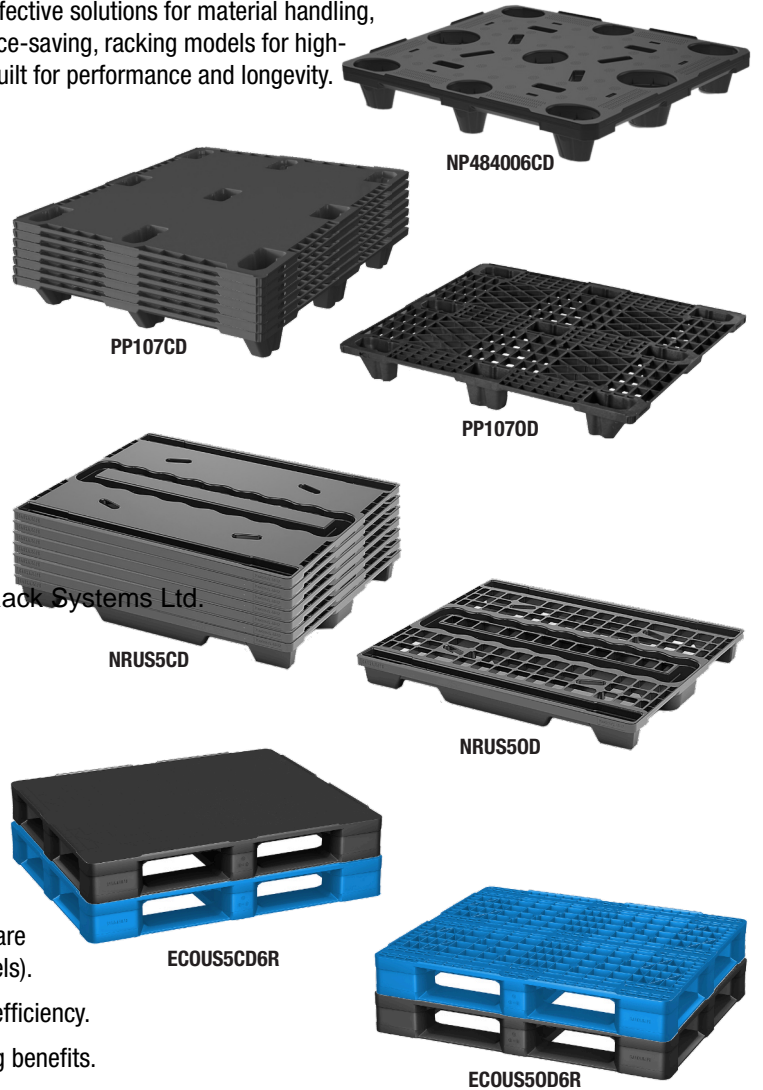

Plastic Pallets			Outside Dimensions (In.)				Other Specifications				
Model Number	Colours	Surface	Length	Width	Height	Weight (Lbs.)	Static Capacity (Lbs.)	Dynamic Capacity (Lbs.)	Racking Capacity (Lbs.)	Pallets Per Stack	
PP1070D	Standard	Open Deck	9 Feet	47-1/5	39-2/5	5-1/8	10.8	3,500	1,650	-	79
PP107CD	Standard	Closed Deck	9 Feet	47-1/5	39-2/5	5-1/8	13.7	3,500	1,650	-	79
NP484006CD	Standard	Closed Deck	9 Feet	48	40	5.8	25	10,000	3,000	-	42
NRUS50D	Standard	Open Deck	3 Runners	48	40	5	21	6,000	3,000	2,200*	46
NRUS5CD	Standard	Closed Deck	3 Runners	48	40	5	22	6,000	3,000	2,200*	46
ECOUS50D6R	Black, Blue	Open Deck	6 Runners	48	40	6-1/8	34	8,800	4,400	2,200	17
ECOUS5CD6R	Black, Blue	Closed Deck	6 Runners	48	40	6-1/8	39.5	8,800	4,400	2,200	17

Other sizes, styles and customizations available with minimum order.
Capacity is dependent upon application and use environment. It is based on equally distributed loads. Elevated temperatures or concentrated loads may affect capacity. *Rackable only when using runners.

BULK CONTAINERS

STRONG, SECURE, BULK SHIPPING MADE EASY



Bulk Containers – Durable, Versatile & Built for Demanding Loads

Our bulk containers are engineered to handle a wide range of industrial applications—from general storage and distribution to heavy-duty material handling. Made from 100% recyclable HDPE, these containers offer long service life, impact resistance, and compatibility with automation systems. With options for reinforced bases, collapsible walls, and extended lengths, there's a model to suit every need.

PRODUCT HIGHLIGHTS:

BG Series – Industry Standard Bulk Containers

- **Capacity:** Rated up to 1,200 lbs.
- **Security:** Locking latches secure panels and doors.
- **Compatibility:** Available with 9 feet or 5 plastic runners.
- **Efficiency:** Has a collapsible return ratio of 3.6:1. Caster-Rack Systems Ltd.

BC Series – Heavy-Duty Bulk Containers

- **Capacity:** Rated up to 1,800 lbs.
- **Compatibility:** Available in 32x30, 48x40, and 48x45 footprints.
- **Strength:** Injection molded, two-piece compression heat-welded base for added durability.
- **Longevity:** Plastic latches and hinges are 100% field repairable.

BN Series – Extra Heavy-Duty Bulk Containers

- **Capacity:** Rated up to 1,800 lbs (32x30) and 2,500 lbs (48x45).
- **Strength:** Superior durability for reliable performance.
- **Compatibility:** Available in 32x30, and 48x45 footprints.
- **Compatibility:** Drop-doors and four-way forklift entry.

BH Series – Heavy-Duty Reinforced Bulk Containers

- **Capacity:** Rated up to 2,500 lbs.
- **Reinforcement:** Includes 3 steel runners for added durability.
- **Strength:** Post-and-pocket side panels interlock securely.
- **Protection:** Steel corner hit plates deflect fork tines.

BS Series – Extended Length Bulk Containers

- **Capacity:** Rated up to 2,000 lbs.
- **Compatibility:** Available with no drop doors, 2 doors, or 4 doors.
- **Access:** Spring latches allow quick assembly and knockdown.
- **Efficiency:** Non-sequential folding prevents wall bowing during collapse.

BF Series – Fixed Wall Bulk Containers

- **Strength:** Solid, one-piece base for maximum durability.
- **Compatibility:** Designed for automation systems.
- **Resistance:** Withstands sunlight, cooling, impact, and moisture.
- **Longevity:** Will not rust, splinter, rot, or absorb odors.





COLLAPSIBLE BULK CONTAINERS

STRONG, SECURE, BULK SHIPPING MADE EASY

Standard Colours

BK



BC32303420



BC48403920



BC48453420



BC48454220

Heavy-Duty Bulk Containers			Outside Dimensions (In.)			Inside Dimensions (In.)			Other Specifications				Fork Tunnel Dimensions (In.)			
Model Number	Colours	Doors	Length	Width	Height	Length	Width	Height	Weight (Lbs.)	Capacity (Lbs.)	Volume (Cu. Ft.)	Return Ratio	Long Side L	Long Side H	Short Side L	Short Side H
BC32302520	Standard	2 Doors on Length	32	30	25	29-1/2	27-1/2	18-1/2	50	1800	8.7	2:1	10-5/8	3-1/2	7-5/8	2
BC32303420	Standard	2 Doors on Length	32	30	34	29-1/2	27-1/2	27-1/2	62	1800	12.9	2.7:1	10-5/8	3-1/2	7-5/8	2
BC48403420	Standard	2 Doors on Length	48	40	34	45	37	27-3/10	106.2	1800	26.3	2:1	12	3-3/4	11-1/2	3-3/4
BC48403920	Standard	2 Doors on Length	48	40	39	45	37	32-3/10	116	1800	31.1	2.5:1	12	3-3/4	11-1/2	3-3/4
BC48452520	Standard	2 Doors on Length	48	44-1/2	25	44-1/2	41-1/2	18-7/5	99	1800	19.5	2:1	11	3-5/16	12-5/16	3-5/16
BC48453420	Standard	2 Doors on Length	48	44-1/2	33-4/5	44-1/2	41-1/2	27	118	1800	28.9	2.7:1	11	3-5/16	12-5/16	3-5/16
BC48454220	Standard	2 Doors on Length	48	44-1/2	41-4/5	44-1/2	41-1/2	35	136.5	1800	37.4	2:1	11	3-5/16	12-5/16	3-5/16
BC48455020	Standard	2 Doors on Length	48	44-1/2	49-4/5	44-1/2	41-1/2	43	155	1800	46.0	1.75:1	11	3-5/16	12-5/16	3-5/16

Other colours, sizes, and customizations available with minimum order.
Capacity is dependent upon application and use environment. It is based on equally distributed loads. Elevated temperatures or concentrated loads may affect capacity.



BN32302520



BN48453420



BN48453420

Extra Heavy-Duty Bulk Containers			Outside Dimensions (In.)			Inside Dimensions (In.)			Other Specifications				Fork Tunnel Dimensions (In.)			
Model Number	Colours	Doors	Length	Width	Height	Length	Width	Height	Weight (Lbs.)	Capacity (Lbs.)	Volume (Cu. Ft.)	Return Ratio	Long Side L	Long Side H	Short Side L	Short Side H
BN32302520	Standard	2 Doors on Length	32	30	25	29-1/2	27-1/2	18-2/5	64	1800	8.6	1.9:1	10-5/8	3-1/2	7-5/8	2
BN32303420	Standard	2 Doors on Length	32	30	34	29-1/2	27-1/2	27-2/5	78	1800	12.9	2.6:1	10-5/8	3-1/2	7-5/8	2
BN48452520	Standard	2 Doors on Length	48	45	25	44-1/2	41-1/2	18-3/10	100	2500	19.1	2.3:1	11	3-5/16	12-5/16	3-5/16
BN48453420	Black, Blue	2 Doors on Length	48	45	34	44-1/2	41-1/2	27	122	2500	28.7	3:1	11	3-5/16	12-5/16	3-5/16
BN48454120	Standard	2 Doors on Length	48	45	41	44-1/2	41-1/2	34	147	2000	36.3	2.1:1	11	3-5/16	12-5/16	3-5/16
BN48454420	Standard	2 Doors on Length	48	45	44	44-1/2	41-1/2	37	154	2000	39.5	2.1:1	11	3-5/16	12-5/16	3-5/16
BN48455120	Standard	2 Doors on Length	48	45	51	44-1/2	41-1/2	44	179	2000	47.0	1.7:1	11	3-5/16	12-5/16	3-5/16

Other colours, sizes, and customizations available with minimum order.
Capacity is dependent upon application and use environment. It is based on equally distributed loads. Elevated temperatures or concentrated loads may affect capacity.

COLLAPSIBLE BULK CONTAINERS

STRONG, SECURE, BULK SHIPPING MADE EASY



Standard Colours

BK

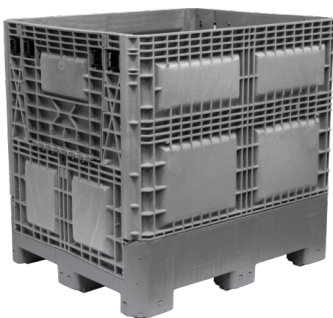

BG48404602

Industry Standard Bulk Containers			Outside Dimensions (In.)			Inside Dimensions (In.)			Other Specifications				Fork Tunnel Dimensions (In.)			
Model Number	Colours	Doors	Length	Width	Height	Length	Width	Height	Weight (Lbs.)	Capacity (Lbs.)	Volume (Cu. Ft.)	Return Ratio	Long Side L	Long Side H	Short Side L	Short Side H
BG48404602	Grey	2 Doors on Width	48	40	46	45	37	40	142	1200	38.5	3.6:1	13	3-1/2	12	3-1/2

Other colours, sizes, and customizations available with minimum order.
Capacity is dependent upon application and use environment. It is based on equally distributed loads. Elevated temperatures or concentrated loads may affect capacity.

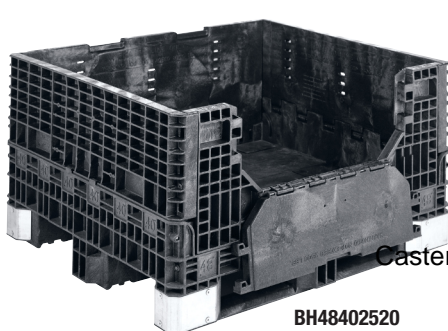

BH48402520



BH48452520

Caster-Rack Systems Ltd

Heavy-Duty Reinforced Bulk Containers			Outside Dimensions (In.)			Inside Dimensions (In.)			Other Specifications				Fork Tunnel Dimensions (In.)				
Model Number	Colours	Doors	Length	Width	Height	Length	Width	Height	Weight (Lbs.)	Capacity (Lbs.)	Volume (Cu. Ft.)	Volume (Gal.)	Return Ratio	Long Side L	Long Side H	Short Side L	Short Side H
BH48402520	Standard	2 Doors on Length	47-3/5	39-4/5	25	44	36-3/10	18-3/10	121.30	2500	16.9	126	2.1:1	11-3/4	3-5/32	10-3/8	4-1/8
BH48403420	Standard	2 Doors on Length	47-3/5	39-4/5	33-9/10	44	36-3/10	26-1/2	141.20	2500	24.5	183	3:1	11-3/4	3-5/32	10-3/8	4-1/8
BH48452520	Standard	2 Doors on Length	47-3/5	44-3/5	25-3/5	44-3/10	41-3/10	18-7/10	140	2500	19.7	148	2.1:1	11-7/8	3-1/4	10-1/2	3-11/16
BH48453420	Standard	2 Doors on Length	47-3/5	44-3/5	34	44-3/10	41-3/10	27-1/10	163	2500	28.7	214	3:1	11-7/8	3-1/4	10-1/2	3-11/16

Other colours, sizes, and customizations available with minimum order.
Capacity is dependent upon application and use environment. It is based on equally distributed loads. Elevated temperatures or concentrated loads may affect capacity.



BS57483420



BS64483420

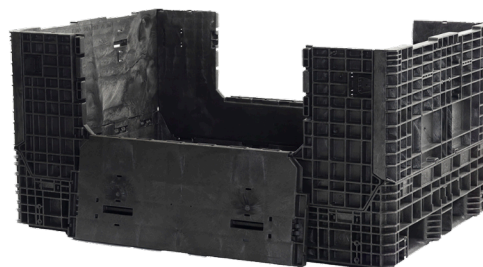

BS70483420

Extended Length Bulk Containers			Outside Dimensions (In.)			Inside Dimensions (In.)			Other Specifications				Fork Tunnel Dimensions (In.)				
Model Number	Colours	Doors	Length	Width	Height	Length	Width	Height	Weight (Lbs.)	Capacity (Lbs.)	Volume (Cu. Ft.)	Volume (Gal.)	Return Ratio	Long Side L	Long Side H	Short Side L	Short Side H
BS57483420	Standard	2 Doors on Length	57-3/10	48	34	53-1/2	44-1/2	26-3/5	171	2000	36.7	274	2.5:1	10-3/16	3-3/16	10-13/16	3-3/16
BS64483420	Standard	2 Doors on Length	64-1/2	48	34	60-4/5	44-1/2	26-3/5	183	2000	41.7	312	2.5:1	10-3/16	3-3/16	10-13/16	3-3/16
BS70483420	Standard	2 Doors on Length	70	48	34	66-3/10	44-1/2	26-3/5	195	2000	45.4	400	2.5:1	10-3/16	3-3/16	10-13/16	3-3/16

Other colours, sizes, and customizations available with minimum order.
Capacity is dependent upon application and use environment. It is based on equally distributed loads. Elevated temperatures or concentrated loads may affect capacity.

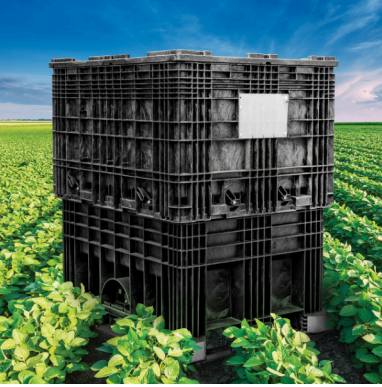

CENTERFLOW CONTAINERS

FAST DISPENSING, DURABLE CONSTRUCTION

Standard Colours

BK

CenterFlow Containers – Fast Dispensing with Industrial Grade

Engineered for speed, durability, and precision, CenterFlow Containers are the go-to solution for transporting and dispensing seed, pellets, granular materials, and small components. With smooth flow and ergonomic handling, these versatile containers combine rugged build quality with operational efficiency.

FEATURES:

- 1 **Efficient Flow Design:** Funnel-shaped interior with a 35° angle and generous export port allows complete emptying in as little as 30 seconds.
- 2 **Heavy-Duty Capacity:** Carries loads up to 2,500 lbs. with reinforced crossbars for even weight distribution.
- 3 **Safe Side Access:** Integrated access door enables easy, one-person operation to dispense partial or full contents.
- 4 **Contamination Control:** Tight-fitting lid keeps out dirt and debris for protected, clean storage.
- 5 **Durable:** Molded from structural foam HDPE for resistance to impact, moisture, and chemicals. Solid oak base rails provide better grip for forklift handling.
- 6 **Smooth Handling:** Compatible with forklifts and pallet jacks, recessed latches secure ring to base for safe transport.

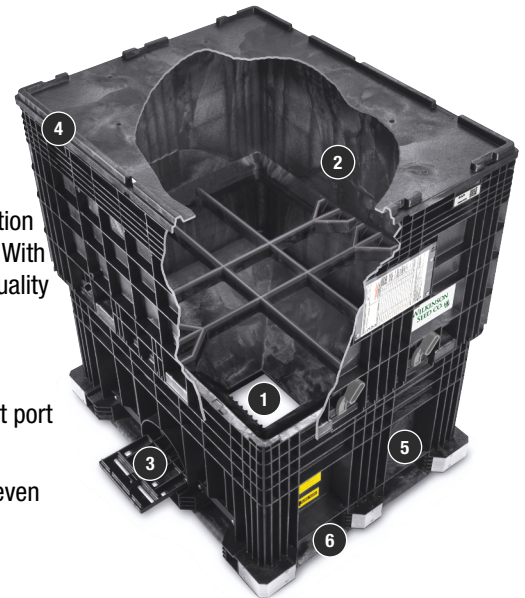

PRODUCT HIGHLIGHTS:

- **Stackable and Nestable:** Saves storage space with a 1.6:1 return ratio.
- **Ergonomic:** Molded for easy handling and efficient flow control.
- **Weather-Ready:** Performs in harsh conditions from -20° to 120°F.
- **Customizable:** Options for labeling and identification available.
- **Sustainable:** 100% recyclable.

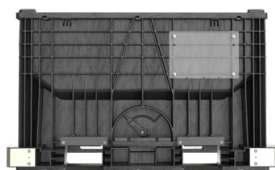

CF574500

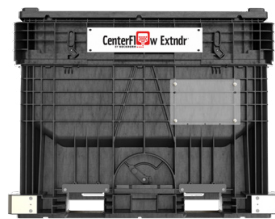

CF574500

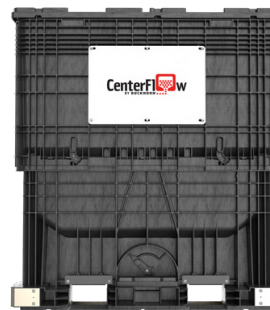

CF574500

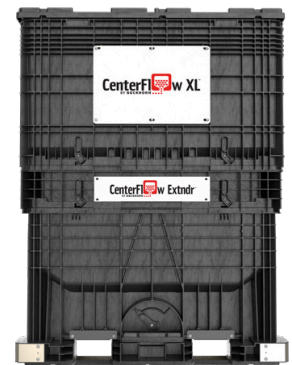

CF574500

Centerflow Containers		Outside Dimensions (In.)			Inside Dimensions (In.)		Other Specifications			Fork Tunnel Dimensions			
Model Number	Colours	Length	Width	Height	Length	Width	Weight (Lbs.)	Capacity (Lbs.)	Volume (Cu. Ft.)	Long Side L	Long Side H	Short Side L	Short Side H
CF57453200	Standard	56-1/2	45	33	49-1/2	38	222	1000	19.8	7-4/5	3-4/5	9-4/5	3-3/5
CF57454100	Standard	56-1/2	45	42	49-1/2	38	266	1500	29.5	7-4/5	3-4/5	9-4/5	3-3/5
CF57456500	Standard	56-1/2	45	64	49-1/2	38	331	2800	58.3	7-4/5	3-4/5	9-4/5	3-3/5
CF57457400	Standard	56-1/2	45	73	49-1/2	38	375	3000	68.0	7-4/5	3-4/5	9-4/5	3-3/5

Other customizations available with minimum order.

INTREPID CONTAINERS

SAFE, SECURE LIQUID AND DRY GOODS HANDLING



Standard Colours



Intrepid™ Bulk Containers – Leak-Resistant, Collapsible & Built for Distribution

Engineered to outperform corrugated combo bins, Intrepid™ bulk containers deliver long-lasting durability, ergonomic access, and cost-efficient collapsibility for demanding material handling applications.

FEATURES:

- 1 **Leak-Proof with Liners:** Heavy-duty injection-molded design with a 2,500 lb capacity protects liquids, powders, and granulates.
- 2 **Space-Saving:** Collapsible, non-sequential folding panels offer a 3.3:1 return ratio—up to 240 units in a 53' trailer.
- 3 **Stackability:** Stable stacking with or without an optional lid; integrated base prevents shifting during transport.
- 4 **Ergonomic:** Optional drop-door improves visibility and liner installation while reducing strain.
- 5 **FDA-Approved:** Compliant construction ensures hygienic storage for food and sensitive goods.
- 6 **Label-Ready:** Textured placard areas on all sides **Custom Rack Systems** support quick ID and tracking.

PRODUCT HIGHLIGHTS:

- **Hygienic:** Smooth surfaces prevent contamination and eliminate debris common with corrugated options.
- **Heavy-Duty:** Withstands harsh conditions across liquid, powder, and bulk ingredient applications.
- **Efficiency:** Reusable design reduces packaging waste and freight costs.
- **Ergonomic:** Provides safe handling for work-in-process, interplant shipments, and temporary storage.
- **Versatile:** Available with top or bottom discharge to meet varied operational needs.
- **Sustainable:** Easy to clean, repair, and recycle for long-term system value.



Intrepid Lids		Outside Dimensions (In.)				Weight (Lbs.)
Model Number	Colours	Length	Width	Height		
TZ48400200	Standard	48-1/10	40-1/10	2-3/10	14.5	

Intrepid Containers			Outside Dimensions (In.)			Inside Dimensions (In.)			Other Specifications				Fork Tunnel Dimensions			
Model Number	Colours	Doors	Length	Width	Height	Length	Width	Height	Weight (Lbs.)	Capacity (Lbs.)	Volume (Gal.)	Return Ratio	Long Side L	Long Side H	Short Side L	Short Side H
BZ48404610	Standard	1 Door	48-1/10	40-1/10	45-9/10	45	37	40-3/10	128.5	2000	300	3.3:1	13-3/5	3-2/5	11-1/8	3-2/5

Other customizations available with minimum order.



CALIBER CONTAINERS

SAFE, SECURE LIQUID AND DRY GOODS HANDLING

Standard Colours



Caliber IBCs – Engineered for Performance, Hygiene & Efficiency

Designed for rugged industrial use, Caliber Intermediate Bulk Containers (IBCs) deliver durable, stackable solutions that meet strict sanitary and operational standards. Ideal for safe, secure liquid handling.

FEATURES:

- 1 **FDA-Compliant Construction:** Injection-molded HDPE with smooth surfaces for hygienic handling.
- 2 **Tamper-Evident Lid:** Eight locking points secure lid to prevent contamination.
- 3 **Stackable Strength:** Safely stacks up to 5 high; embedded steel rods reinforce side walls for added load support, each holding up to 3,000 lbs.
- 4 **Discharge Flexibility:** Offers top or bottom discharge.
- 5 **Smart Tracking:** Dual molded-in RFID tags for inventory control and process monitoring.
- 6 **Space-Saving Design:** Collapsible format with a **Castor Pack System** for shipping efficiency.
- 7 **Forklift-Friendly:** Four-way entry for easy movement in any direction.

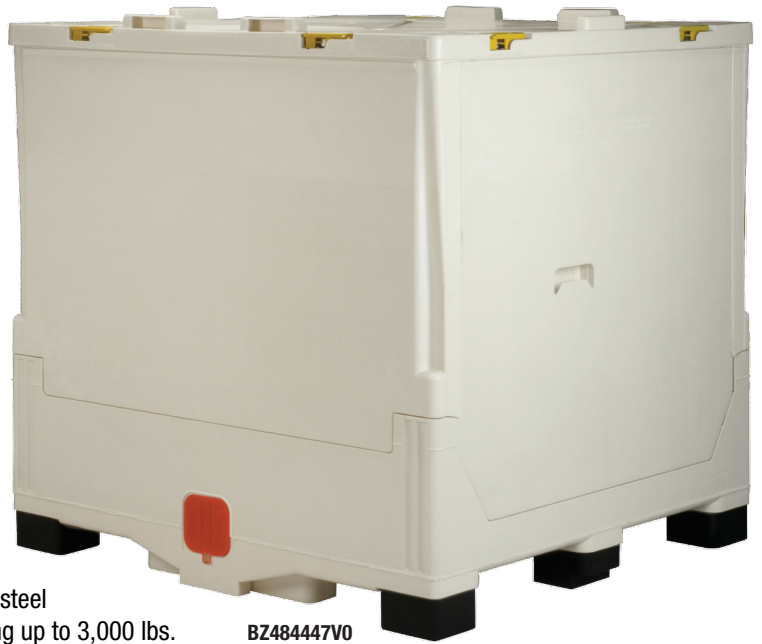

BZ484447V0

PRODUCT HIGHLIGHTS:

- **Hygienic:** FDA-grade surfaces maintain product purity in sensitive environments.
- **Heavy-Duty:** Built to withstand pressure filling, stacking, and repeated handling.
- **Secure:** Tamper-resistant lid and structural reinforcements protect contents in transit.
- **Space-Efficient:** Stackable and collapsible design saves warehouse and return freight space.
- **Customizable:** Label placards, RFID, and colour options tailor each unit to its application.



Caliber Containers			Outside Dimensions (In.)			Inside Dimensions (In.)			Other Specifications				Fork Tunnel Dimensions			
Model Number	Colours	Discharge	Length	Width	Height	Length	Width	Height	Weight (Lbs.)	Capacity (Lbs.)	Volume (Gal.)	Return Ratio	Long Side L	Long Side H	Short Side L	Short Side H
BZ484447V0	Standard	Bottom	48-3/5	44-7/10	48	44-9/10	40-9/10	40-9/10	225	3307	315	2.5:1	13-2/5	3-2/5	11-1/2	3-5/16

Other customizations available with minimum order.

FIXED WALL BULK CONTAINERS

SMOOTH INTERIOR, SAFEGUARD FRAGILE GOODS



Standard Colours



BF42292800



BF48442900

Fixed Wall Bulk Containers			Outside Dimensions (In.)			Inside Dimensions (In.)			Other Specifications				Fork Tunnel Dimensions (In.)				
Model Number	Colours	Doors	Length	Width	Height	Length	Width	Height	Weight (Lbs.)	Capacity (Lbs.)	Volume (Cu. Ft.)	Volume (Gal.)	Return Ratio	Long Side L	Long Side H	Short Side L	Short Side H
BF42292800	Standard	0 Doors	41-4/5	28-4/5	27-4/5	38-1/2	25-1/2	22-3/10	74	900	13.8	103.3	1:1	10-1/2	3-7/8	-	-
BF48442900	Standard	0 Doors	48	44	29-2/5	45-2/5	41-2/5	23-2/5	95	700	25.9	185.2	1:1	11-7/10	3-1/8	11-7/10	4-5/16

Other colours, sizes, and customizations available with minimum order.
Capacity is dependent upon application and use environment. It is based on equally distributed loads. Elevated temperatures or concentrated loads may affect capacity.

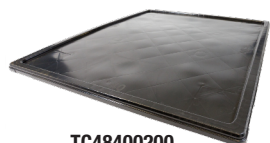

TC48400200



TH48400200



TL42290400

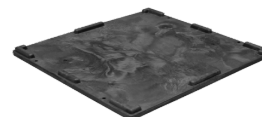

TS32300200

Caster-Rack Systems Ltd.



TC48450300

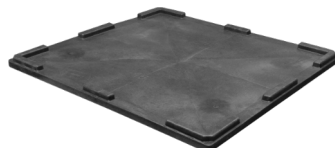

TH48450200

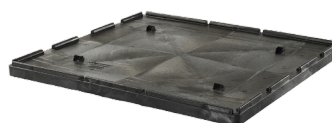

TL48440300

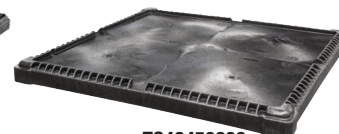

TS48450300

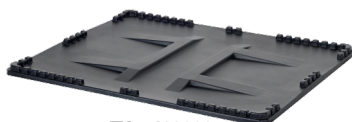

TV57480200

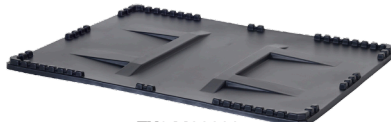

TV64480200



TV70480200

Bulk Container Lids			Outside Dimensions (In.)			Weight (Lbs.)
Model Number	Compatibility	Colours	Length	Width	Height	
TC48400200	BC4840 Series	Standard	48-1/2	40-1/2	1-2/5	11.7
TC48450300	BC4845 and BN4845 Series	Standard	48-9/10	45-9/10	2-3/5	14.1
TH48400200	BH4840 Series	Standard	48-2/5	40-2/5	2-1/10	18.6
TH48450200	BH4845 Series	Standard	48-2/5	45-2/5	2-3/10	20.7
TL42290400	BF4229 Series	Black, Grey	42-1/2	29-7/10	3-1/5	15.3
TL48440300	BF4844 Series	Black, Grey	48-9/10	44-4/5	2-4/5	20.9
TS32300200	BC3230 and BN3230 Series	Standard	32-4/5	30-4/5	2-3/10	10.3
TS48450300	BC4845 and BN4845 Series	Standard	49-4/5	46-4/5	3-4/5	25
TV57480200	BS5748 Series	Standard	57-1/2	48-1/5	2-1/10	18
TV64480200	BS6448 Series	Standard	64-4/5	48-1/5	2-1/10	21
TV70480200	BS7048 Series	Standard	70-7/10	48-1/5	2-1/10	22

Other colours and customizations available with minimum order.



FORKLIFT BINS

STACKABLE STRENGTH FOR BULK HANDLING

Standard Colours



Forklift Bins – Stackable Strength for Efficient Bulk Handling

Designed for rugged industrial use, Forklift Bins combine durability, stackability, and seamless maneuverability to optimize your material handling and storage. Built tough with thoughtful features, these bins are ideal for shipping, warehousing, and bulk transport operations.

FEATURES:

- 1 **Four-Sided Forklift Access:** Lift and move bins effortlessly from any angle using standard forklift equipment.
- 2 **Nest & Stack Design:**
 - Nest when empty to reduce storage footprint.
 - Stack securely when full to maximize space.
- 3 **Corner Nesting Stops:** Barrel-type nesting stops in each corner ensure stable stacking and safe nesting.
- 4 **Heavy-Duty Construction:** Both bin and lid are robust—built to endure heavy use and allow vertical stacking.
- 5 **Optional Lid Available:** Protect contents from dust and debris; sold separately.

Note: Model 4900 is not compatible with standard pallet trucks.

PRODUCT HIGHLIGHTS:

- **Durable:** Engineered for high-impact handling in industrial environments.
- **Effortless:** Four-way forklift entry streamlines mobility and access.
- **Space-Saving:** Nestable and stackable to cut shipping costs and storage space.
- **Customizable:** Optional lids offer content protection and added versatility.

ACCESSORIES:

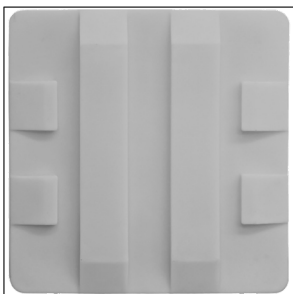

Lid

Available on all forklift bins



4900

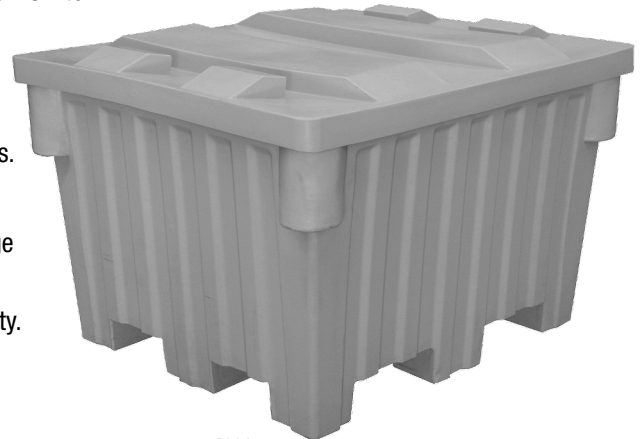

4800

Forklift Bin Accessories		Outside Dimensions (In.)			Weight (Lbs.)
Model Number	Description	Length	Width	Height	Weight (Lbs.)
4800LID	Lid for 4800 Forklift Bin	48	42	3	30
4900LID	Lid for 4900 Forklift Bin	44	44	3	30

Other colours, sizes and customizations available upon request (minimum orders apply).

Forklift Bins		Outside Dimensions (In.)			Other Specifications		
Model Number	Colours	Length	Width	Height	Volume (Cu. Ft.)	Weight (Lbs.)	Capacity (Lbs.)
4800	Grey	48	42	30	24	75/30	1200
4900	Standard	44	44	46	38	90/30	2000

Other colours, sizes and customizations available upon request (minimum orders apply).

PORTABLE ORGANIZERS

SMALL PARTS STORAGE

Standard Colours



Tote Caddy – Grab-and-Go Storage for Tools & Supplies

Stay organized on the move with the compact and rugged Tote Caddy. Designed for portability and versatility, this hand-held caddy is perfect for carrying tools, hardware, cleaning supplies, and more—wherever the job takes you.

FEATURES:

- 1 Compact:** Lightweight, hand-held design makes it easy to carry from station to station.
- 2 Functional:** Deep compartments hold tools, loose parts, or cleaning supplies. Two shallow trays keep small items like hardware, keys, or fasteners within easy reach.
- 3 Durable:** Molded from heavy-duty, industrial-grade polymers with a textured finish for enhanced grip and long-lasting durability.



09185

Tote Caddy		Outside Dimensions (In.)			Other Specifications	
Model Number	Colours	Length	Width	Height	Weight (Lbs.)	Carton Quantity
09185	Standard	13-7/8	18-3/8	6	2.66	6

Order in carton quantities.

Standard Colours



ProBox™ Toolboxes – Rugged, Secure & Ready for Any Task

From emergency kits to everyday tool transport, the ProBox™ Toolbox is built to handle it all. With a tough exterior, smart interior layout, and tamper-evident security, this toolbox is the perfect companion for professionals and DIYers alike.

FEATURES:

- 1 Versatile:** Ideal for use as a supply tote, emergency kit, or portable toolbox.
- 2 Functional:** Includes a removable tray (14" model), keeps small tools and parts organized and easily accessible.
- 3 Durable:** Molded from industrial-grade polymers for long-lasting durability in tough environments.
- 4 Secure:** Oversized padlock eye fits most padlocks or zip ties for added protection. (14" Model) Provides a secure closure and added strength for transport.

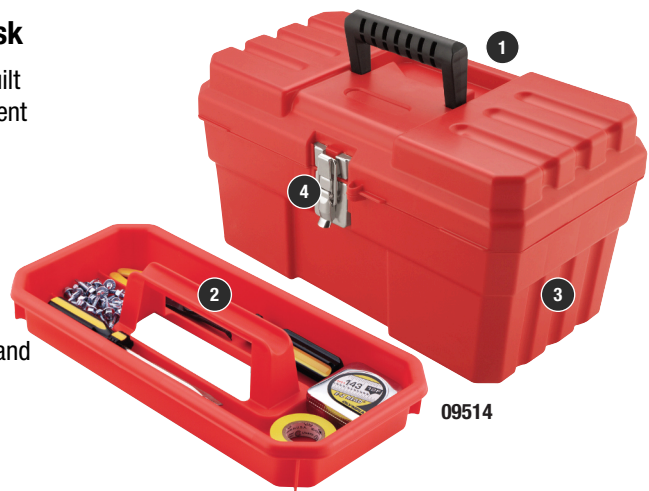

09514



09912

Supply Box		Outside Dimensions (In.)			Other Specifications	
Model Number	Colours	Length	Width	Height	Weight (Lbs.)	Carton Quantity
09912	Standard	12	6	4	0.75	12
09514	Standard	14	8-1/8	8-1/8	2.00	3 / 6*

Order in carton quantities.*Red version ships in cartons of 6, clear version ships in cartons of 3.

STORAGE CASES: UTILITY BOXES

CUSTOMIZABLE, LIGHTWEIGHT, PORTABLE STORAGE



Standard Colours



Compartment Boxes – Organized, Customizable & Built to Contain It All

Keep small parts exactly where they belong with our convenient compartment boxes. Perfect for hardware, fasteners, and craft supplies.

FEATURES:

- 1 Functional:** Unique lid design prevents parts from shifting between compartments when closed.
- 2 Dividable:** Includes adjustable dividers for personalized storage layouts on both levels, tailor each box to your exact needs.

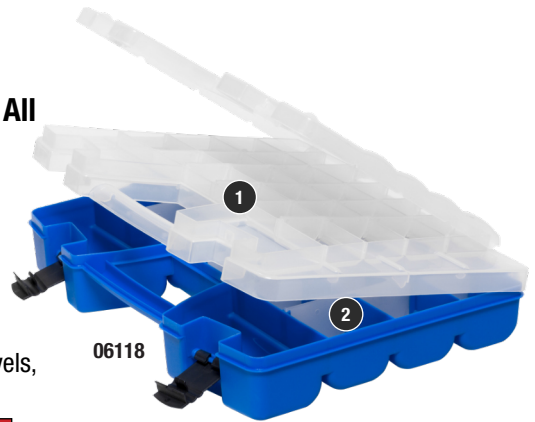

Portable Organizers		Outside Dimensions (In.)			Other Specifications	
Model Number	Description	Length	Width	Height	Maximum Compartments	Carton Quantity
06118	Lid Storage Organizer	18-1/4	13-1/2	3-3/4	12 to 62	1

Order in carton quantities.

Clear Storage Cases – See It. Store It. Secure It.

Stay organized with Clear Storage Cases - designed for visibility, versatility, and secure compartmental storage.

FEATURES:

Caster-Rack Systems Ltd.

- 1 Grid Lid:** Prevents items from shifting between compartments, even when on the move.
- 2 Customizable Layout:** Includes adjustable dividers for front-to-back configuration, so you can tailor each case to your needs.
- 3 Clear Construction:** Made from durable, industrial-grade clear polymers for easy content visibility and long-lasting use.



Storage Cases		Outside Dimensions (In.)			Other Specifications	
Model Number	Description	Length	Width	Height	Maximum Compartments	Carton Quantity
05705	2 Fixed Dividers; 4 Adjustable Dividers	8-5/8	5-1/8	1-5/8	15	12
05805	2 Fixed Dividers; 4 Adjustable Dividers	11	7	2-3/8	15	6
05905	2 Fixed Dividers; 5 Adjustable Dividers	14-3/8	9-1/2	2-1/2	18	6

Order in carton quantities.



Utility Boxes – Compact, Customizable & Kit-Ready

Simplify your storage with Utility Boxes - ideal for creating organized kits for tools or supplies.

FEATURES:

- 1 Versatile:** Great for assembling kits, organizing small parts, or storing craft and hobby supplies.
- 2 Adjustable:** Includes 2 adjustable dividers to create custom compartment sizes.
- 3 Flat Lid:** Smooth surface makes it easy to label contents for quick identification.

Utility Boxes		Outside Dimensions (In.)			Other Specifications	
Model Number	Description	Length	Width	Height	Maximum Compartments	Carton Quantity
96352A	Medium Utility Box – 5 Fixed Dividers	8-5/16	4-5/8	1-1/2	18	12
96352B	Large Utility Box – 4 Fixed Dividers	11	6-3/8	2-1/2	15	6

Order in carton quantities.



PLASTIC CABINETS

IMPACT RESISTANT, SMALL PARTS ORGANIZATION



Standard Colours
BK

Plastic Bin Cabinets – Impact Resistant, Built to Organize

Made from recycled materials and designed for durability, these cabinets offer a clean, modular approach to part storage with stackable flexibility and clear visibility.

FEATURES:

- 1 **Rugged Construction:** Built with high-impact plastic for long-lasting use.
- 2 **Reinforced Structure:** Interlocking frame and face add strength and help maintain cabinet integrity.
- 3 **Integrated Drawer Dividers:** Molded dividers on the cabinet back keep parts separated and organized.

PRODUCT HIGHLIGHTS:

- **Sustainable:** Cabinet frames made from 100% recycled plastic.
- **Stackable:** Designed to stack vertically for expanded storage options.
- **Wall-Mountable:** Features four rear keyhole slots for easy wall installation.
- **Dividable:** Includes a limited set of drawer dividers; additional dividers available separately.
- **Variety:** Available in 5 cabinet models to suit various storage needs.

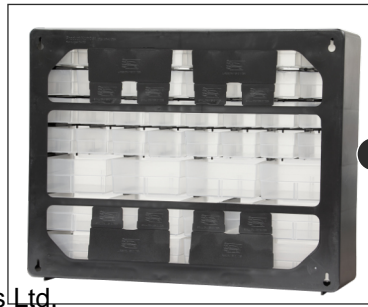
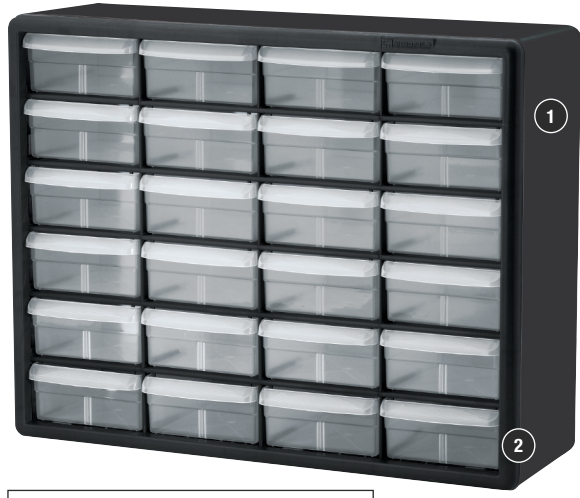

10116

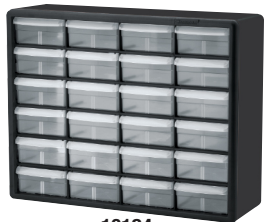

10124



10126



10144



10164



Large Drawer:

Outside Dimensions:
6" x 4-9/16" x 2-3/16"

Inside Dimensions:
4-7/8" x 4-1/4" x 2-3/32"

Small Drawer:

Outside Dimensions:
6" x 2-7/32" x 1-9/16"

Inside Dimensions:
5-1/4" x 1-11/16" x 1-1/2"

Additional Dividers (Plastic Cabinets)	
Model Number	Description
40716	16-Pack additional dividers for small drawers
40717	6-Pack additional dividers for large drawers

Plastic Storage Cabinets		Drawer Quantity			Outside Dimensions (In.)		
Model Number	Colours	Large	Small	Total Drawers	Length	Width	Height
10116	Standard	-	16	16	10-1/2	6-3/8	8-1/2
10124	Standard	24	-	24	20	6-3/8	15-13/16
10126	Standard	6	20	26	20	6-3/8	10-1/4
10144	Standard	12	32	44	20	6-3/8	15-13/16
10164	Standard	-	64	64	20	6-3/8	15-13/16

Order in carton quantities.

STEEL STORAGE CABINETS

HEAVY-DUTY, HIGH-DENSITY STORAGE



Standard Colours

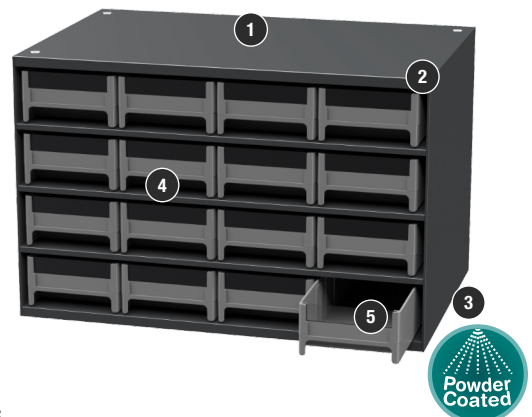
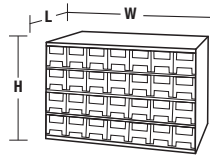

19 Series Steel Bin Cabinets – Compact and Customizable

Engineered for safe small-part storage and easy identification, the 19 Series Steel Bin Cabinets combine rugged welded steel construction with modular compatibility across storage systems. Now manufactured out of galvennealed steel for superior corrosion protection.

FEATURES:

- 1 **Durable Powder-Coated Finish:** Chip-resistant surface protects against scratches and corrosion.
- 2 **Heavy-Duty Steel Frame:** Welded 24-gauge cabinet body delivers reliable long-term strength.
- 3 **Stackable Design:** Built-in nesting feet ensure safe, stable vertical stacking.
- 4 **Quick Identification:** Label holder and clear drawer window simplify content visibility.
- 5 **High-Quality Drawers:** Industrial-grade plastic drawers designed for long-term use.
- 6 **Flexible Organization:** Dovetail dividers (included) allow up to 8 compartments per drawer.



PRODUCT HIGHLIGHTS:

Caster-Rack Systems Ltd.

- **Functional:** Ideal for organizing small parts with a compact footprint: 17"W × 11"D × 11"H; drawers: 10-9/16" deep.
- **Safe:** Rounded edges and rear drawer stop tab help prevent spills and damage.
- **Expandable:** Integrates with Rail Racks, ProCart™, Storage-Go-Round, and Louvered Panels using optional suspension straps.
- **Wall-Mountable:** Four keyhole slots on the back allow for easy mounting to vertical surfaces.

ACCESSORIES:

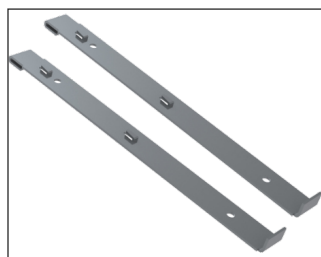

98400
Suspension Straps (Set of 2)



19-Series Cabinets
on ProCart
(see page 66)

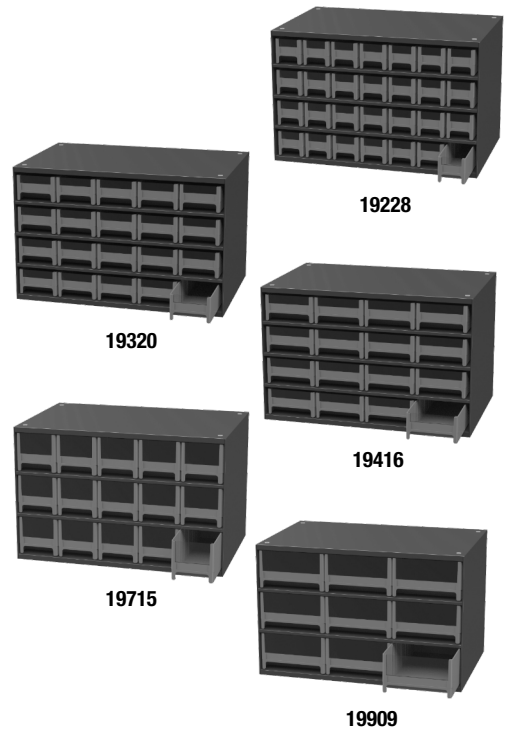

19-Series Steel Cabinets		Outside Dimensions (In.)			Drawer Dimensions (In.)			Accessories		
Model Number	Drawers Per Cabinet	Length	Width	Height	Length	Width	Height	Weight (Lbs.)	Drawer Model Number.	Dividers
19228	28	11	17	11	10-9/16	2-3/16	2-1/16	20.50	20228	40228 (24/Pkg)
19320	20	11	17	11	10-9/16	3-3/16	2-1/16	20.50	20320	40320 (30/Pkg)
19416	16	11	17	11	10-9/16	4	2-1/8	19.50	20416	40416 (33/Pkg)
19715	15	11	17	11	10-9/16	3-3/16	3-1/16	18.75	20715	40715 (30/Pkg)
19909	9	11	17	11	10-9/16	5-3/16	3-1/16	18.00	20909	40909 (27/Pkg)

Other colours and customizations available upon request (minimum orders apply). One label per drawer included.

STEEL STORAGE CABINETS

HEAVY-DUTY, HIGH-DENSITY STORAGE



Standard Colours



19- Series Drawers	Outside Dimensions (In.)			Weight (Lbs.)
Model Number	Length	Width	Height	
20228	10-9/16	2-3/16	2-1/16	0.32
20320	10-9/16	3-3/16	2-1/16	0.41
20416	10-9/16	4	2-1/8	0.48
20715	10-9/16	3-3/16	3-1/16	0.56
20909	10-9/16	5-3/16	3-1/16	0.93

*Other colours and customizations available upon request (minimum orders apply).

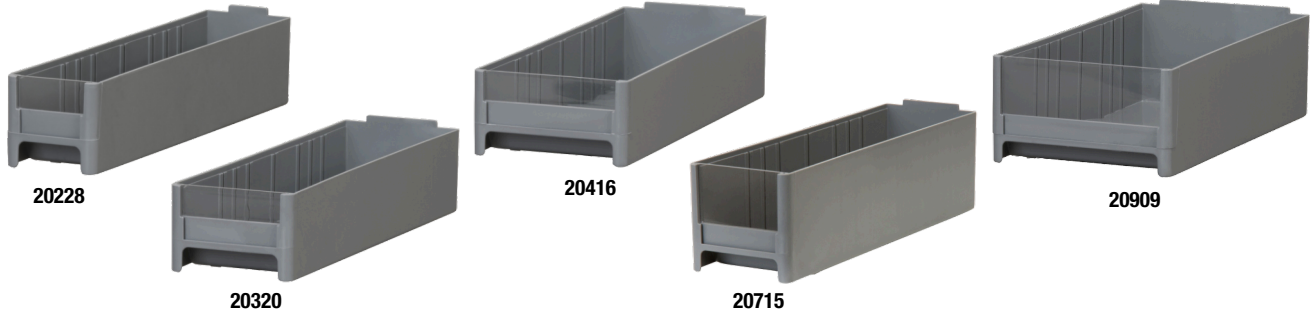

Storage-Go-Round – High Capacity, Small Footprint, Total Access

Optimize your space and streamline workflow with the Storage-Go-Round—a rotating bin storage unit that packs up to 1,000 lbs. of organized parts into just one square yard.

FEATURES:

- High-Capacity Design:** Securely holds (20) 19-Series cabinets, sold separately.
- Compact Workspace Footprint:** Swing diameter measures just 43-5/8" for space-saving.
- Smooth Rotation Base:** Ball-transfer base enables easy part access.
- Durable Finish:** Tough powder-coated surface resists chips, scratches, and corrosion.
- Customizable Appearance:** Mix and match drawer colours and sizes to elevate organization and aesthetics.

PRODUCT HIGHLIGHTS:

- Capacity:** Supports up to 1,000 lbs. of parts across 20 mounted steel cabinets.
- Efficient:** Ideal for pick stations and assembly areas where speed and organization matter.
- Dust-Free:** Cabinet and drawer design minimizes dust accumulation for cleaner storage.

UP TO
1000
LBS.

Powder
Coated

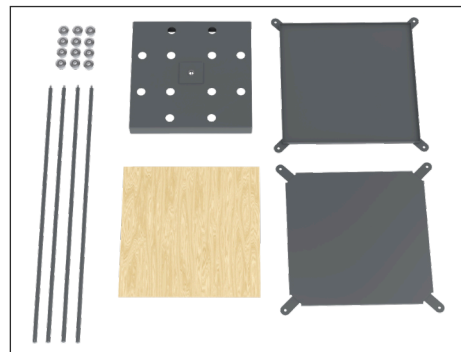

Model No 98325
19-Series Cabinets sold separately.

Storage-Go-Round	Outside Dimensions (In.)			Weight (Lbs.)
Model Number	Length	Width	Height	
98325	31	31	60	109

Assembly required. 19-Series Cabinets sold separately.



HEAVY DUTY STEEL CABINETS

CUSTOMIZABLE, ALL-WELDED, SECURE STORAGE

Standard Colours



CUSTOM STORAGE SOLUTIONS

Customize steel cabinets with Hanging and Stacking Bins and InSight® Bins (sold separately), or shelf bins with the optional shelves.

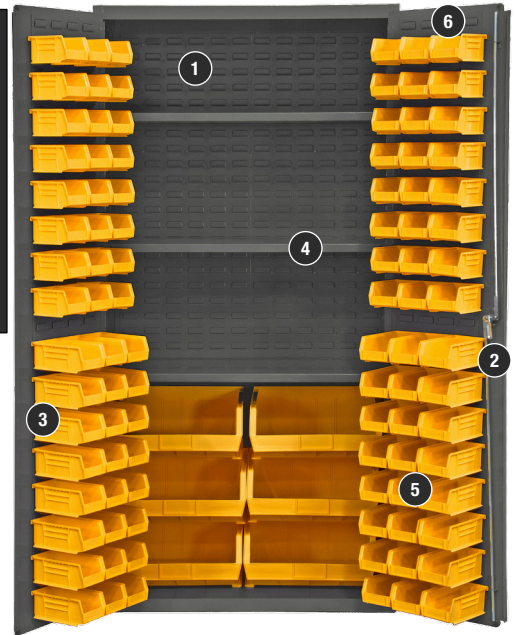

Heavy-Duty All-Welded Bin Storage Cabinets

Designed for demanding environments, these cabinets combine rugged steel construction with flexible storage options. Ideal for organizing tools, parts, and supplies in industrial, commercial, or maintenance settings.

FEATURES:

- 1 **Construction:** All-welded, 14-gauge steel for maximum strength and durability.
- 2 **Security:** 3-point locking system with keyed handle and lock rods; 4 keys included.
- 3 **Access:** Double doors open at 180° for full visibility and easy product retrieval.
- 4 **Adjustability:** Shelves rest on louvered panels and adjust on 4" centers—no tools required.
- 5 **Compatibility:** Optional Hanging and Stacking Bins available (sold separately).
- 6 **Reinforcement:** Fully welded louvered panels strengthen doors and support bins.
- 7 **Assembly:** Cabinets ship fully assembled for immediate use.
- 8 **Finish:** Durable, textured grey powder coat resists wear and corrosion.

Castle Back Systems Ltd.

PRODUCT HIGHLIGHTS

- **Durability:** Heavy-duty steel construction built for industrial use.
- **Protection:** Secure locking system safeguards contents.
- **Convenience:** Full-access doors simplify loading and retrieval.
- **Flexibility:** Tool-free shelf and bin installation for fast setup.
- **Customization:** Pair with optional bins and shelves for tailored storage.
- **Sizing:** Available in 18" and 24" depths to suit your space.

ACCESSORIES:

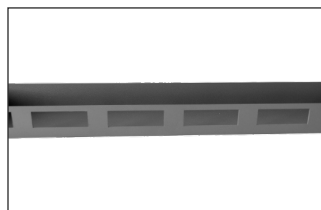

Door Shelves
Shelves for louvered doors

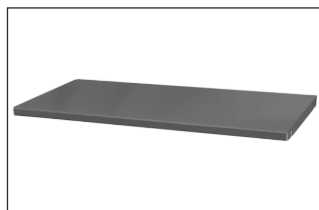

Cabinet Shelves
Shelves for louvered back

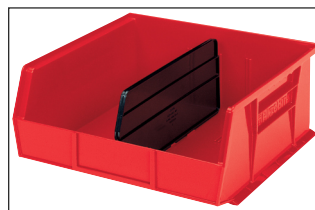

Hanging and Stacking Bins
Bins for louvers (see page 3-6)



3602-BLP-95



3501-BLP-95

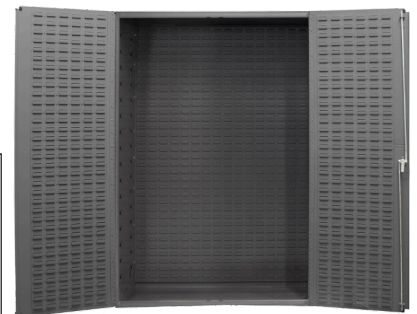

3502-BLP-95

Heavy Duty Steel Cabinets		Outside Dimensions (In.)			Other Specifications				
Model Number	Colours	Depth	Width	Height	Weight (Lbs.)	Gauge	Available Louvers	Door Shelf	Back Shelf
3602-BLP-95	Standard	18	36	72	288	14	Back	-	FDC-SH-3618-95
3501-BDLP-95	Standard	24	36	72	326	14	Back and Door	DSH-124-95	FDC-SH-3618-95
3502-BDLP-95	Standard	24	48	72	400	14	Back and Door	DSH-184-95	FDC-SH-4818-95

Other sizes and customizations available upon request with minimum orders. Bins and shelves not included.

LOUVERED HANGING SYSTEMS

CUSTOMIZABLE VERTICAL STORAGE FOR HANGING BINS



Standard Colours



Louvered Panels – Built for Space-Saving Organization

Transform your workspace with durable Louvered Panels—designed to support bin systems with style and strength. Perfect for wall-mounted applications or full rack installations, these panels create a streamlined, vertical storage solution that keeps supplies accessible and off the floor.

FEATURES:

- 1 **Secure Bin Support:** Compatible with Hanging and Stacking Bins and InSight® Bins (sold separately), ensuring stable and efficient storage.
- 2 **Heavy-Duty Construction:** Crafted from 16-gauge cold-rolled steel for lasting durability in any environment.
- 3 **Powder-Coated Finish:** Smooth and resilient surface resists wear while maintaining a clean, professional appearance.
- 4 **Pre-Mounted Convenience:** Models 30661, 30638, and 30676 feature full louvered panels mounted to heavy-duty frames.

PRODUCT HIGHLIGHTS:

- **Efficient:** Keep items out of the way and off work surfaces—ideal for tight spaces and high-functioning workstations.
- **Floor Racks:** Freestanding racks improve productivity by placing supplies right where you need them.
- **Single-Sided Racks:** Great for wall placement to conserve valuable floor space.
- **Double-Sided Racks:** Provide double the storage in one compact footprint—convenient access from both sides.
- **Mobile Options:** Add mobility kits to make your rack systems easy to relocate without unloading bins.

HOW TO CHOOSE Louvers vs. Rails

Louvers: Steel panels with rows of punched louvers. More storage capacity, greater selection of styles. Panels can be attached to the wall, freeing floor space. Rivet racks come with the panels already riveted to the frame.

Rails: Constructed of individual steel rails that span between uprights. Weigh less than louvered panels, more economical, small footprint, easy to remove bins from rails.

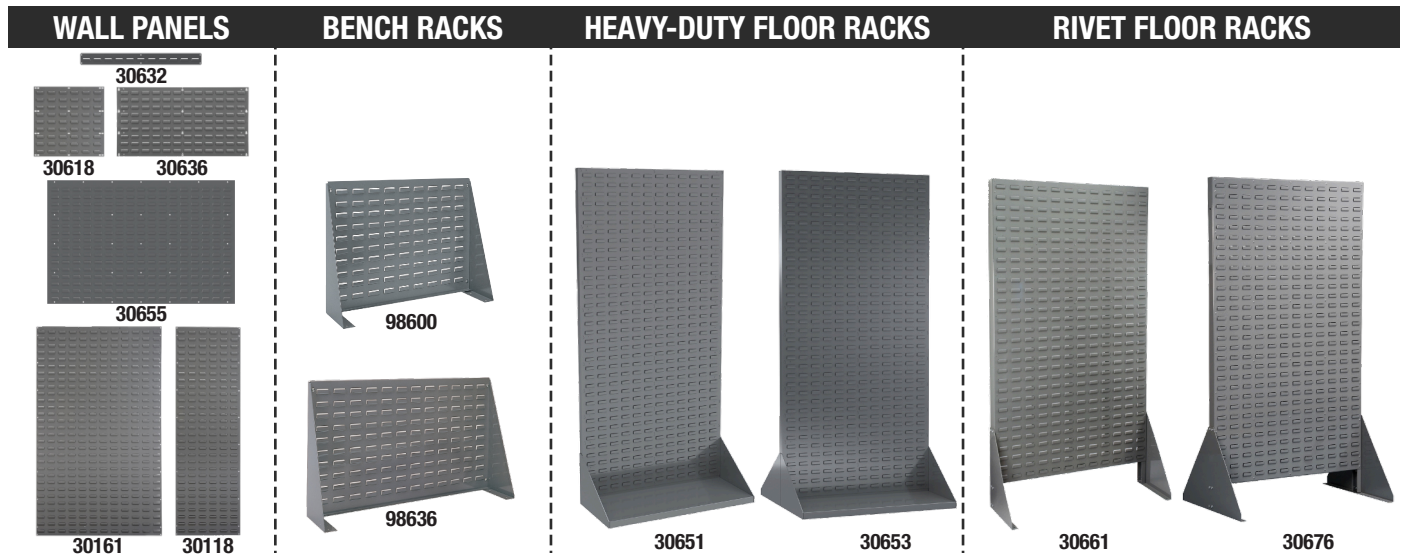

LOUVERED HANGING SYSTEMS

CUSTOMIZABLE VERTICAL STORAGE FOR HANGING BINS



Standard Colours



98600 with 30220

CUSTOM STORAGE SOLUTIONS

Customize louvered panels with Hanging and Stacking Bin and InSight® Bins (sold separately), or shelf bins with the optional 30635 shelf.

Louvered Hanging Systems		Outside Dimensions (In.)				Hanging and Stacking Bin Quantity to Fit Louvered Hanging System														
Model Number	Description	Length	Width	Height	Rack Wt. Cap. (lbs.)	30210	30220	30224	30230	30234	30235	30237	30239	30240	30250	30255	30260	30265	30270	30320
30618	Louvered Wall Panel	18	5/16	19	160	16	16	12	9	9	3	6	4	4	2	3	1	2	1	-
30632	Single Row Louvered Panel	31-15/16	5/16	3	80	7	7	7	5	5	2	5	3	3	1	1	2	3	1	-
30636	Louvered Wall Panel	35-3/4	5/16	19	160	32	32	24	18	18	9	15	8	8	4	6	3	4	2	3
	2 Louvered Wall Panels	35-3/4	5/16	37	-	72	72	48	36	36	18	30	16	16	8	12	9	12	6	6
	3 Louvered Wall Panels	35-3/4	5/16	55	-	104	104	72	54	54	27	45	24	24	12	18	12	20	8	9
	4 Louvered Wall Panels	35-3/4	5/16	73	-	144	144	96	72	72	36	60	36	36	18	24	18	28	12	12
30655	Louvered Wall Panel	52	5/16	34-1/8	750	96	96	60	45	45	20	40	24	24	12	15	8	18	6	5
30161	Louvered Wall Panel	36	5/16	61	1000	120	120	80	60	60	30	50	28	28	14	20	15	24	10	10
30118	Louvered Wall Panel	18	5/16	61	500	60	60	40	30	30	10	20	14	14	7	10	5	12	5	-
30651	HD Single-Sided Floor Rack	35-3/4	17	75-1/8	1000	144	144	96	72	72	36	60	36	36	18	24	18	28	12	12
30653	HD Double-Sided Floor Rack	35-3/4	32	75-1/8	2000	144	144	96	72	72	36	60	36	36	18	24	18	28	12	12
30658	Double-Sided Rivet Floor Rack	18	25	66-3/8	500	120	120	80	60	60	20	40	28	28	14	20	10	24	10	-
30661	Single-Sided Rivet Floor Rack	36-3/16	13-1/2	66-3/8	500	120	120	80	60	60	30	50	28	28	14	20	15	24	10	10
30676	Double-Sided Rivet Floor Rack	36-3/16	25	66-3/8	1000	240	240	160	120	120	60	100	56	56	28	40	30	48	20	20
98600	Louvered Bench Rack	27-15/16	8-9/16	19-9/16	120	30	30	18	12	12	6	12	6	6	2	3	2	6	-	-
98636	Louvered Bench Rack	36	8	20	120	40	40	24	18	18	9	15	8	8	4	6	3	8	-	3

CAUTION: When using bins with hanging systems, do not exceed the weight capacity for the rack, which may be less than the total sum of bin capacities.

ACCESSORIES:



30661DOLLY
Mobile Kit for 30676

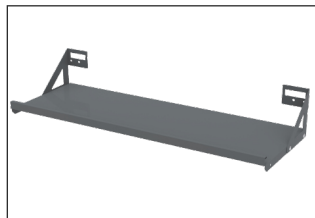

30635
Shelf for Louvered Panels

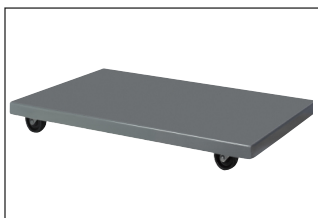

LVDMOBILE
Mobile Kit for 30661

Louvered Hanging System Accessories		Outside Dimensions (In.)			Capacity (Lbs.)
Model Number	Description	Length	Width	Height	Capacity (Lbs.)
LVDMOBILE	Mobile Kit for 30676	-	-	-	1500
30661DOLLY	Mobile Kit for 30661	37	24	6	500
30635	Shelf for Louvered Panels	12-3/4	35-5/8	6-7/16	50

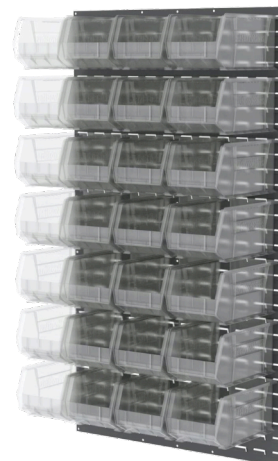

30161 with 30240 Bins



30161 with 30255 Bins

RAIL HANGING SYSTEMS

BUILT FOR FAST, EFFICIENT PART RETRIEVAL



Standard Colours



Steel Rail Systems – Support for Efficient Bin Organization

Maximize vertical space with Steel Rail Systems—engineered to hold bin-based storage solutions securely while offering fast, accessible part retrieval. Ideal for workshops, warehouses, and supply rooms.

FEATURES:

- 1 **Heavy-Duty Build:** Crafted from 14-gauge steel for reliable bin support and long-term durability.
- 2 **Powder-Coated Finish:** Resists wear while maintaining a clean, professional look.
- 3 **Bin Compatibility:** Supports Hanging and Stacking Bins, 19-Series Cabinets, and InSight® Ultra-Clear Bins (sold separately).

PRODUCT HIGHLIGHTS:

- **Efficient:** Organize tools and parts for quick retrieval.
- **Single-Sided:** Space-saving units ideal for wall placement.
- **Double-Sided:** Freestanding units allow dual access and flexible placement.
- **Mobile Kit:** Optional accessories enable movement of double-sided racks.
- **Wall Mount:** Rail systems easily mount to walls—perfect for workstations and inventory areas.



Caster-Rack Systems Ltd.

HOW TO CHOOSE Louvers vs. Rails

Louvers: Steel panels with rows of punched louvers. More storage capacity, greater selection of styles. Panels can be attached to the wall, freeing floor space. Rivet racks come with the panels already riveted to the frame.

Rails: Constructed of individual steel rails that span between uprights. Weigh less than louvered panels, more economical, small footprint, easy to remove bins from rails.



Rail Hanging Systems		Outside Dimensions (In.)			Other Specifications	
Model Number	Colours	Length	Width	Height	Weight (Lbs.)	Capacity (Lbs.)
30008*	Standard	36	14-1/8	53	54	250
30016*	Standard	36	20	53	64	500
30148	Standard	47-13/16	5/8	3	5.25	110
30812	Standard	38-1/2	24	36-1/2	82	250
AWRAIL	Blue	12	1/8	1-7/16	0.1	20

*Can be assembled as a 12 or 16 rail rack.

RAIL HANGING SYSTEMS

BUILT FOR FAST, EFFICIENT PART RETRIEVAL

Standard Colours

GY



30812 Mobile Rack Cart with 30230RED Bins



30016 Rail Rack with 30235YELLOW Bins



30016 Rail Rack with 30240CLEAR Bins

Hanging and Stacking Bin Quantity to Fit Rail Hanging Systems															InSight Bins				
Model Number	30210	30220	30224	30230	30234	30235	30237	30239	30240	30250	30255	30260	30265	30270	305A1	305A3	305A5	305B1	19-Series Cabinets
30008	96	96	64	48	48	24	40	24	24	12	16	12	16	8	96	96	96	48	6
30016	192	192	128	96	96	48	80	48	48	24	32	24	32	16	192	192	192	96	12
30148	11	11	11	8	8	4	8	5	5	2	2	4	5	2	11	11	11	8	2
30812	96	96	64	48	48	24	40	24	24	12	16	12	16	8	96	96	96	48	12

CAUTION: When using bins with hanging systems, do not exceed the weight capacity for the rack, which may be less than the total sum of bin capacities.

ACCESSORIES:



30424
Mobile Kit for Rail Rack



98400
Suspension Straps (Set of 2)



30016 with (1) 30424,
(12) 98400, (12) 19715

UP TO
500
LBS.

Powder
Coated

CUSTOM STORAGE SOLUTIONS

Customize rail systems with Hanging and Stacking Bins and InSight® Bins (sold separately), or shelf bins with the optional 30635 shelf.



30424 Mobile Kit
with Rail Rack

Rail Hanging Systems Accessories				
Model Number	Description	Capacity (Lbs.)	Compatibility	Casters
30424	Mobile Kit (Casters and Handle)	500	30016	4" Polyolefin
98400	Suspension Straps (Set of 2)	-	30008, 30016, 30812	-

98400 suspension straps required for hanging 19-Series cabinets. Two straps needed to secure cabinet to rack.



PICK RACKS

HIGH-DENSITY STORAGE WITH ANGLE SHELVES

Standard Colours



Pick Racks – Built Strong for Fast, Efficient Part Retrieval

Boost organization and productivity with Pick Racks—engineered to keep supplies front and center. Whether you’re outfitting a workbench or a storage station, these racks streamline picking processes and stand up to demanding environments.

FEATURES:

- 1 **16-Gauge Steel Construction:** Provides durable, long-lasting support for high-traffic use.
- 2 **Angled Shelves:** Designed to keep bins tilted forward so contents stay visible and accessible.
- 3 **Bin Compatibility:** Works seamlessly with Shelf Bins, Indicator® Bins, Drawer Bins, and System Bins™.
- 4 **Powder-Coated Finish:** Durable coating resists wear and adds a clean, professional look.
- 5 **Mobile Ready:** Optional mobile kits are available (sold separately).

PRODUCT HIGHLIGHTS:

- **Efficient:** Keeps parts organized and accessible—perfect for fast-paced workstations.
- **Heavy-Duty:** Supports up to 1,800 lbs. with Double-Sided 18” racks; Bench Rack holds 100 lbs. per shelf.
- **Versatile:** Choose from Single-Sided, Double-Sided, or Bench Rack configurations, available in both 12” and 18” shelf depths.

Caster-Rack Systems Ltd



APRD with 30120YELLOW shelf bins and APRDMOBILE

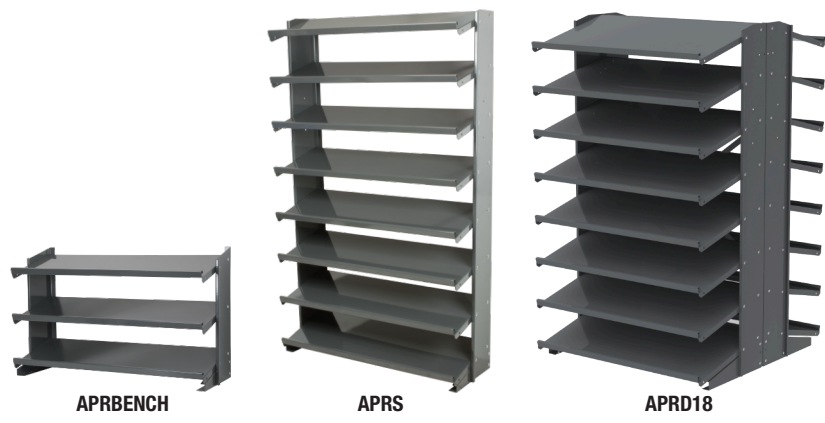

APRBENCH

APRS

APRD18

CUSTOM STORAGE SOLUTIONS

Customize Pick Racks with Shelf Bins, Indicator® Bins, Drawer Bins, or System Bins.

Pick Rack Accessories		Dimensions (In.)			Capacity (Lbs.)
Model No.	Description	Length	Width	Height	Capacity (Lbs.)
APRDMOBILE	Mobile Kit for APRD	24	33	4	500
APRD18MOBILE	Mobile Kit for APRD18	37	33	6-3/4	1800

Steel Pick Racks	Outside Dimensions (In.)			Shelf Dimensions (in.)			Other Specifications		
Model Number	Length	Width	Height	Length	Width	Height	Weight (Lbs.)	Capacity (Lbs.)	Mobile Kit
APRS	12	36-3/4	60-1/4	12-1/8	35-5/8	6-7/16	110	400	-
APRD	24	36-3/4	60-1/4	12-1/8	35-5/8	6-7/16	222	800	APRDMOBILE
APRS18	18	36-3/4	60-1/4	18-1/8	35-5/8	6-7/16	147	900*	-
APRD18	36	36-3/4	60-1/4	18-1/8	35-5/8	6-7/16	280	1800**	APRD18MOBILE
APRBENCH	12	36-3/4	21-1/4	12-1/8	35-5/8	6-7/16	36	250	-

*When anchored to wall and floor. **When anchored to floor.

PICK RACKS

HIGH-DENSITY STORAGE WITH ANGLE SHELVES

Standard Colours

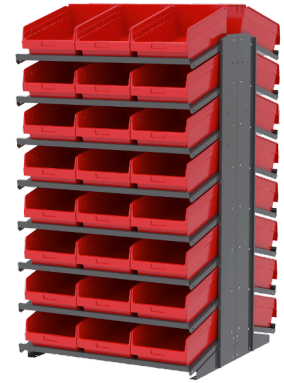
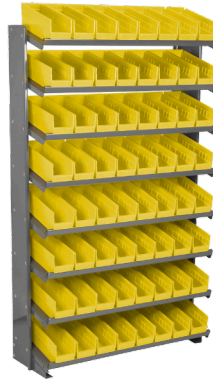

APRS with 30120 bins

APRS with 30130 bins

APRD18 with 30018 bins

CUSTOM STORAGE SOLUTIONS

Customize Pick Racks with Shelf Bins, Indicator® Bins, Drawer Bins, or System Bins.

HOW MANY BINS FIT ON MY PICK RACK?

12" Single Sided Rack	Outside Bin Dimensions (In.)			
Model Number	Length	Width	Height	Bin Quantity
30110	11-5/8	2-3/4	4	96
30120	11-5/8	4-1/8	4	64
30130	11-5/8	6-5/8	4	40
30150	11-5/8	8-3/8	4	32
30170	11-5/8	11-1/8	4	24
30040	11-5/8	4-1/8	6	64
30080	11-5/8	8-3/8	6	32
30090	11-5/8	6-5/8	6	40
30010	11-5/8	11-1/8	6	24
36442	11-5/8	4-1/4	4	64
36462	11-5/8	6-3/4	4	40
31112	11-5/8	11-1/8	4-5/8	24
31142	11-5/8	3-3/4	4-5/8	72
31162	11-5/8	5-9/16	4-5/8	48
31182	11-5/8	8-3/8	4-5/8	32
30312	12	33	5	8

Bins are sold in carton quantities.

12" Double Sided Rack	Outside Bin Dimensions (In.)			
Model Number	Length	Width	Height	Bin Quantity
30110	11-5/8	2-3/4	4	192
30120	11-5/8	4-1/8	4	128
30130	11-5/8	6-5/8	4	80
30150	11-5/8	8-3/8	4	64
30170	11-5/8	11-1/8	4	48
30040	11-5/8	4-1/8	6	128
30080	11-5/8	8-3/8	6	64
30090	11-5/8	6-5/8	6	80
30010	11-5/8	11-1/8	6	48
36442	11-5/8	4-1/4	4	128‡
36462	11-5/8	6-3/4	4	80‡
31112	11-5/8	11-1/8	4-5/8	48
31142	11-5/8	3-3/4	4-5/8	144
31162	11-5/8	5-9/16	4-5/8	96
31182	11-5/8	8-3/8	4-5/8	64
30312	12	33	5	16

Bins are sold in carton quantities.

18" Single Sided Rack	Outside Bin Dimensions (In.)			
Model Number	Length	Width	Height	Bin Quantity
30128	17-7/8	4-1/8	4	72
30138	17-7/8	6-5/8	4	48
30158	17-7/8	8-3/8	4	36
30178	17-7/8	11-1/8	4	24
30048	17-7/8	4-1/8	6	64
30088	17-7/8	8-3/8	6	32
30098	17-7/8	6-5/8	6	40
30018	17-7/8	11-1/8	6	24
36448	17-7/8	4-1/8	4	72
36468	17-7/8	6-5/8	4	48
31148	17-5/8	3-3/4	4-5/8	72
31168	17-5/8	5-9/16	4-5/8	48
31188	17-5/8	8-3/8	4-5/8	32
31118	17-5/8	11-1/8	4-5/8	24
30318	18	33	5	8

Bins are sold in carton quantities.

18" Double Sided Rack	Outside Bin Dimensions (In.)			
Model Number	Length	Width	Height	Bin Quantity
30128	17-7/8	4-1/8	4	132
30138	17-7/8	6-5/8	4	84
30158	17-7/8	8-3/8	4	72
30178	17-7/8	11-1/8	4	48
30048	17-7/8	4-1/8	6	128
30088	17-7/8	8-3/8	6	64
30098	17-7/8	6-5/8	6	80
30018	17-7/8	11-1/8	6	48
36448	17-7/8	4-1/8	4	132
36468	17-7/8	6-5/8	4	84
31148	17-5/8	3-3/4	4-5/8	144
31168	17-5/8	5-9/16	4-5/8	96
31188	17-5/8	8-3/8	4-5/8	64
31118	17-5/8	11-1/8	4-5/8	48
30318	18	33	5	16

Bins are sold in carton quantities.



WIRE SHELVING

CUSTOMIZABLE SHELVING: FOR ALL YOUR STORAGE NEEDS

Standard Colours



Ak-West Inc. Wire shelving is a popular storage system to consumers and industrial users alike. With storage capacities of 600-1,000 lbs per shelf, wire shelving will help organize any area.

The open wire truss-reinforced shelves permit light to penetrate, allow free air circulation and give greater visibility of merchandise. Moisture and dust accumulation are reduced, and maximum effectiveness of sprinkler systems is ensured. Assembly is simple and quick.

**ASSEMBLING WIRE SHELVING IS AS EASY AS
1-2-3**



Caster-Rack Systems Ltd.

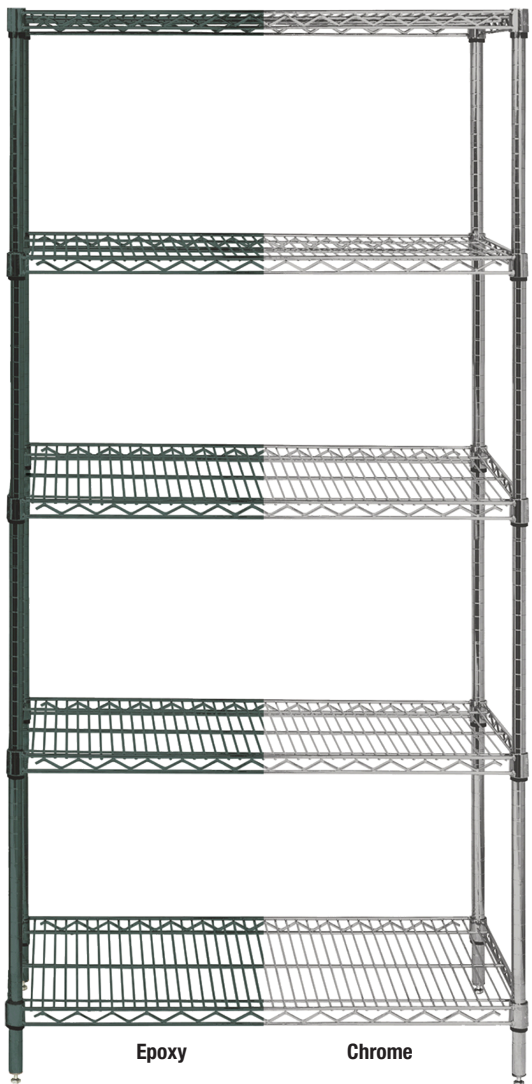

Epoxy

Chrome

CUSTOM STORAGE SOLUTIONS

Customize your wire shelving with Shelf Bins, Indicator® Bins, Stacking Bins, Drawer Bins, or System Bins.



Which finish is best for you?

Chrome: Very durable and allows product to be used in any dry storage application.

Epoxy: An ideal solution for high humidity, wet, or walk-in-cooler applications.

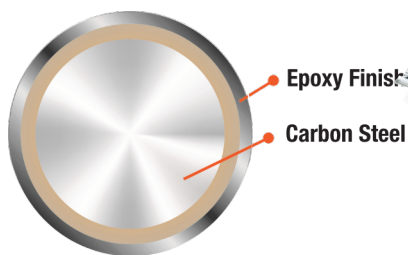
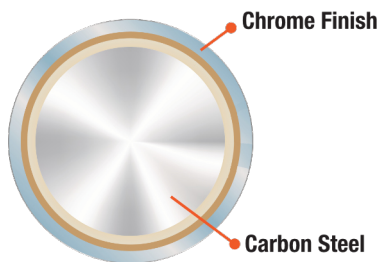



WIRE SHELVING STARTER KITS

READY TO ASSEMBLE WIRE SHELVING

Standard Colours



Chrome & Epoxy Wire Shelving – Starter Kits

Optimize storage and meet compliance by elevating your supplies off the floor with durable wire shelving that assembles in minutes; no tools required.

PRODUCT HIGHLIGHTS:

- **Regulatory Ready:** Keep inventory off the ground to meet facility compliance standards.
- **Clean Visibility:** Open-wire design minimizes dust buildup and enhances item visibility.
- **Quick Setup:** Tool-free assembly makes installation simple and efficient.
- **Strong Load Capacity:** Shelves hold up to 800 lbs. (<48") or 600 lbs. (>48").
 - **Starter Unit Includes:** 4 wire shelves, 4 posts with levelling feet, quick-adjust sleeves.
- **Label-Ready:** Easily integrate shelf labelling systems.

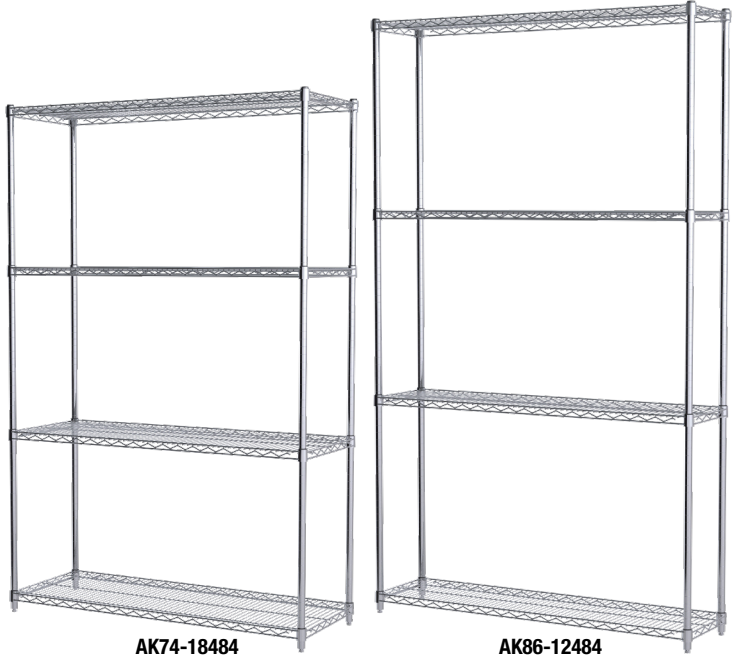

AK74-18484 4 Shelf Starter Kit

AK86-12484 4 Shelf Starter Kit

54" H Wire Starter Kits	Outside Dimensions (In.)			Other Specifications	
Model Number	Length	Width	Height	Post Quantity	Shelf Quantity
AK54-12364	12	36	54	4	4
AK54-12484	12	48	54	4	4
AK54-18364	18	36	54	4	4
AK54-18484	18	48	54	4	4
AK54-18604	18	60	54	4	4
AK54-18724	18	72	54	4	4
AK54-24364	24	36	54	4	4
AK54-24484	24	48	54	4	4
AK54-24604	24	60	54	4	4
AK54-24724	24	72	54	4	4

Other sizes and customizations available with minimum order. Specify chrome or epoxy finish when ordering.

63" H Wire Starter Kits	Outside Dimensions (In.)			Other Specifications	
Model Number	Length	Width	Height	Post Quantity	Shelf Quantity
AK63-12364	12	36	63	4	4
AK63-12484	12	48	63	4	4
AK63-18364	18	36	63	4	4
AK63-18484	18	48	63	4	4
AK63-18604	18	60	63	4	4
AK63-18724	18	72	63	4	4
AK63-24364	24	36	63	4	4
AK63-24484	24	48	63	4	4
AK63-24604	24	60	63	4	4
AK63-24724	24	72	63	4	4

Other sizes and customizations available with minimum order. Specify chrome or epoxy finish when ordering.

74" H Wire Starter Kits	Outside Dimensions (In.)			Other Specifications	
Model Number	Length	Width	Height	Post Quantity	Shelf Quantity
AK74-12364	12	36	74	4	4
AK74-12484	12	48	74	4	4
AK74-18364	18	36	74	4	4
AK74-18484	18	48	74	4	4
AK74-18604	18	60	74	4	4
AK74-18724	18	72	74	4	4
AK74-24364	24	36	74	4	4
AK74-24484	24	48	74	4	4
AK74-24604	24	60	74	4	4
AK74-24724	24	72	74	4	4

Other sizes and customizations available with minimum order. Specify chrome or epoxy finish when ordering.

86" H Wire Starter Kits	Outside Dimensions (In.)			Other Specifications	
Model Number	Length	Width	Height	Post Quantity	Shelf Quantity
AK86-12364	12	36	86	4	4
AK86-12484	12	48	86	4	4
AK86-18364	18	36	86	4	4
AK86-18484	18	48	86	4	4
AK86-18604	18	60	86	4	4
AK86-18724	18	72	86	4	4
AK86-24364	24	36	86	4	4
AK86-24484	24	48	86	4	4
AK86-24604	24	60	86	4	4
AK86-24724	24	72	86	4	4

Other sizes and customizations available with minimum order. Specify chrome or epoxy finish when ordering.

WIRE SHELVING ADDER KITS

READY TO ASSEMBLE WIRE SHELVING



Standard Colours



Chrome & Epoxy Wire Shelving – Adder Kits

Optimize storage and meet compliance by elevating your supplies off the floor with durable wire shelving that assembles in minutes; no tools required.

PRODUCT HIGHLIGHTS:

- **Expandable Configuration:** Add-on units extend shelving runs with minimal additional posts.
- **Adder Unit Includes:** 4 wire shelves, 2 posts, 8 S-hooks (2 per shelf), quick-adjust sleeves.

INCLUDES S-HOOKS

1 package of S-Hooks is included with every 4-shelf adder shelf kit. Available in chrome and epoxy finishes.

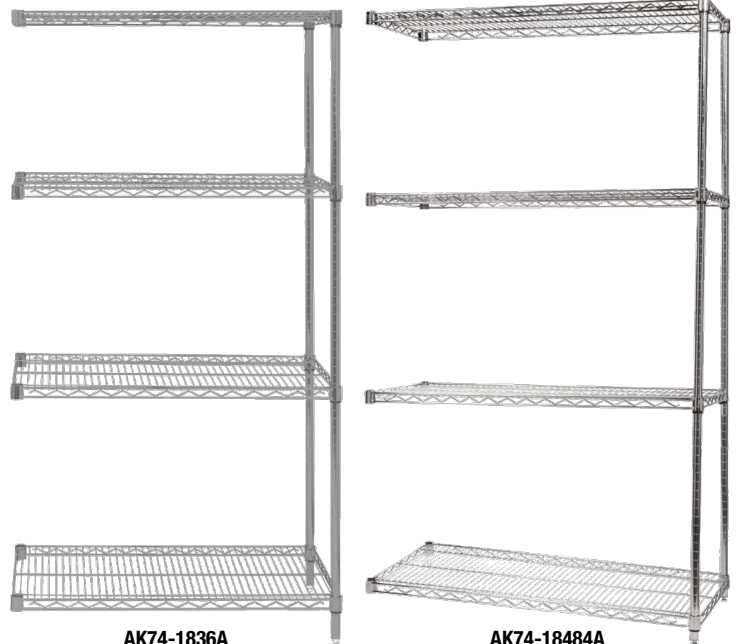

AK74-1836A
4 Shelf Adder Kit

AK74-18484A
4 Shelf Adder Kit

54" H Wire Adder Kits	Outside Dimensions (In.)			Other Specifications	
Model Number	Length	Width	Height	Post Quantity	Shelf Quantity
AK54-12364A	12	36	54	2	4
AK54-12484A	12	48	54	2	4
AK54-18364A	18	36	54	2	4
AK54-18484A	18	48	54	2	4
AK54-18604A	18	60	54	2	4
AK54-18724A	18	72	54	2	4
AK54-24364A	24	36	54	2	4
AK54-24484A	24	48	54	2	4
AK54-24604A	24	60	54	2	4
AK54-24724A	24	72	54	2	4

Other sizes and customizations available with minimum order. Specify chrome or epoxy finish when ordering.

63" H Wire Adder Kits	Outside Dimensions (In.)			Other Specifications	
Model Number	Length	Width	Height	Post Quantity	Shelf Quantity
AK63-12364A	12	36	63	2	4
AK63-12484A	12	48	63	2	4
AK63-18364A	18	36	63	2	4
AK63-18484A	18	48	63	2	4
AK63-18604A	18	60	63	2	4
AK63-18724A	18	72	63	2	4
AK63-24364A	24	36	63	2	4
AK63-24484A	24	48	63	2	4
AK63-24604A	24	60	63	2	4
AK63-24724A	24	72	63	2	4

Other sizes and customizations available with minimum order. Specify chrome or epoxy finish when ordering.

74" H Wire Adder Kits	Outside Dimensions (In.)			Other Specifications	
Model Number	Length	Width	Height	Post Quantity	Shelf Quantity
AK74-12364A	12	36	74	2	4
AK74-12484A	12	48	74	2	4
AK74-18364A	18	36	74	2	4
AK74-18484A	18	48	74	2	4
AK74-18604A	18	60	74	2	4
AK74-18724A	18	72	74	2	4
AK74-24364A	24	36	74	2	4
AK74-24484A	24	48	74	2	4
AK74-24604A	24	60	74	2	4
AK74-24724A	24	72	74	2	4

Other sizes and customizations available with minimum order. Specify chrome or epoxy finish when ordering.

86" H Wire Adder Kits	Outside Dimensions (In.)			Other Specifications	
Model Number	Length	Width	Height	Post Quantity	Shelf Quantity
AK86-12364A	12	36	86	2	4
AK86-12484A	12	48	86	2	4
AK86-18364A	18	36	86	2	4
AK86-18484A	18	48	86	2	4
AK86-18604A	18	60	86	2	4
AK86-18724A	18	72	86	2	4
AK86-24364A	24	36	86	2	4
AK86-24484A	24	48	86	2	4
AK86-24604A	24	60	86	2	4
AK86-24724A	24	72	86	2	4

Other sizes and customizations available with minimum order. Specify chrome or epoxy finish when ordering.



WIRE SHELF COMPONENTS

BUILD YOUR IDEAL SHELVING SYSTEM

Standard Colours



CUSTOM STORAGE SOLUTIONS

Order the exact size shelves, posts and custom components to fit your space requirements!

Customize Wire Shelving with Shelf Bins, Stacking Bins, Indicator® Bins, Drawer Bins, or System Bins.

Horizontal Shelves – NSF Certified Strength

Certified Clean: NSF-approved wire shelves for hygienic storage environments.

Quick-Adjust Clips: Durable plastic clips included with each shelf (Replacement: AWCLIP).

High Load Ratings:

Shelves up to 48": Holds up to 800 lbs (evenly distributed).

Shelves over 48": Holds up to 600 lbs (evenly distributed).

Stationary Unit: Total weight capacity up to 2,000 lbs.

Fast Setup: Assembles in minutes, no tools required.

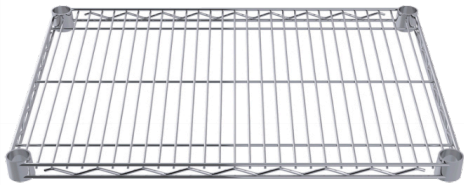

Chrome Wire Shelf



Grey Epoxy Wire Shelf

Caster-Rack Systems Ltd.

Wire Shelves			Outside Dimensions (In.)			
Model Number	Description	Colours	Length	Width	Height	Carton Quantity
AK1224SHELF	12" x 24" Wire Shelf	Standard	12	24	1-1/4	4
AK1236SHELF	12" x 36" Wire Shelf	Standard	12	36	1-1/4	4
AK1248SHELF	12" x 48" Wire Shelf	Standard	12	48	1-1/4	4
AK1824SHELF	18" x 24" Wire Shelf	Standard	18	24	1-1/4	4
AK1836SHELF	18" x 36" Wire Shelf	Standard	18	36	1-1/4	4
AK1848SHELF	18" x 48" Wire Shelf	Standard	18	48	1-1/4	4
AK1860SHELF	18" x 60" Wire Shelf	Standard	18	60	1-1/4	2
AK1872SHELF	18" x 72" Wire Shelf	Standard	18	72	1-1/4	2
AK2424SHELF	24" x 24" Wire Shelf	Standard	24	24	1-1/4	4
AK2436SHELF	24" x 36" Wire Shelf	Standard	24	36	1-1/4	4
AK2448SHELF	24" x 48" Wire Shelf	Standard	24	48	1-1/4	4
AK2460SHELF	24" x 60" Wire Shelf	Standard	24	60	1-1/4	2
AK2472SHELF	24" x 72" Wire Shelf	Standard	24	72	1-1/4	2

Other sizes, customizations and finishes available with minimum order.

Wire Posts			Outside Dimensions (In.)			
Model Number	Description	Colours	Length	Width	Height	Carton Quantity
AK34POST	34" Shelf Post	Standard	1-1/4	1-1/4	34	4
AK39POST	39" Shelf Post	Standard	1-1/4	1-1/4	39	4
AK54POST	54" Shelf Post	Standard	1-1/4	1-1/4	54	4
AK63POST	63" Shelf Post	Standard	1-1/4	1-1/4	63	4
AK74POST	74" Shelf Post	Standard	1-1/4	1-1/4	74	4
AK86POST	86" Shelf Post	Standard	1-1/4	1-1/4	86	4
AK96POST	96" Shelf Post	Standard	1-1/4	1-1/4	96	4

Other sizes, customizations and finishes available with minimum order.

Upright Posts

Leveling Foot: Built-in adjustment compensates for uneven floors.

Top Cap & Base Insert: Each post includes a plastic top cap and a base insert, compatible with standard feet and optional casters.

Height Options: Available in multiple sizes from 34" to 96".



Posts include leveling foot



Chrome



Grey Epoxy

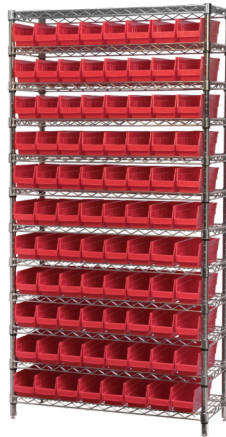

Wire shelving with 30120 bins



Wire shelving with 30130 bins



Wire shelving with 30150 bins

WIRE SHELVING ACCESSORIES

CUSTOMIZE WITH ESSENTIAL ACCESSORIES



Standard Colours

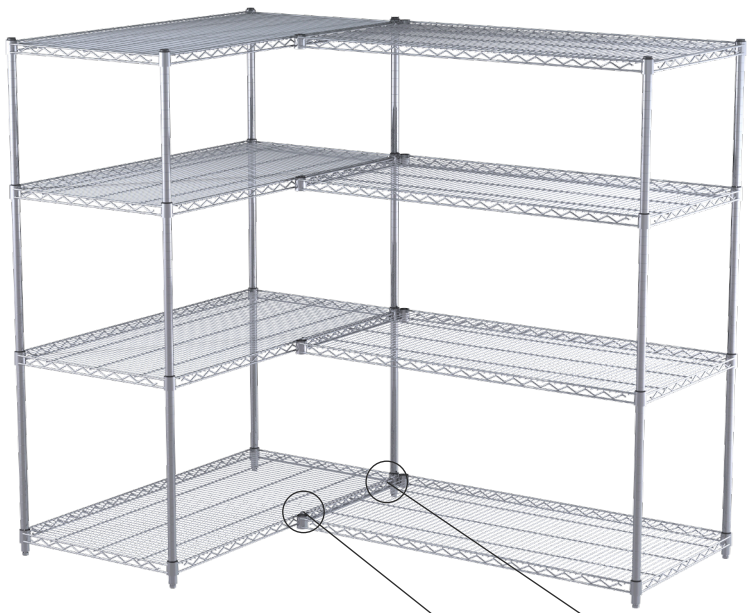

Swivel Casters

Create mobile shelving units and carts with these swivel caster sets.

5" casters, 2 with brakes, 2 without brakes.

Push Handles

Create mobile shelving units and carts with handles.

"S" Hooks

Allow for continuous runs or 90° angles.

Use two hooks per shelf.

Post Clamps

Secure two shelf kits together by connecting their posts with a joining bar.

Post clamps leave a 1/2" gap between posts.

Leveling Feet

Levels shelving units on uneven surfaces.

Steel Foot Plate

Provides extra stability to shelving units.

Allows shelving to be secured to the floor.

Donut Bumper

Slides onto bottom of upright posts.

Add them to mobile units to prevent damage to walls.

Quick-Adjust Clips

For assembling shelves to posts.

Caster-Rack Systems Ltd.

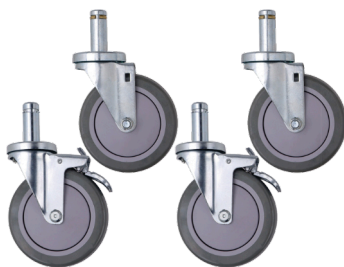

AK5CASTER2SB2S
(2) w/ brakes, (2) w/o brakes



Push Handle



"S" Hooks



Post Clamp



Leveling Feet



Steel Foot Plate



Donut Bumper



Quick-Adjust Clips

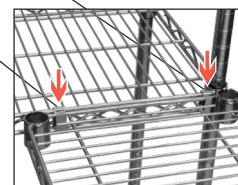

Wire Shelving Accessories			
Model Number	Description	Colours	Package Quantity
AKSHOOK	S-Hooks (Package of 8)	Standard	8
AKFP	Foot Plate for AK Series Posts	Chrome	1
AWDONUT	3" Donut Bumper for Wire Posts	Black	1
AK5CASTER	5" Polyurethane Casters, 2 w/ Brakes, 2 w/o Brakes	Grey	4
AKPH18	18" Push Handle	Standard	1
AKPH24	24" Push Handle	Standard	1
AWCLIP	Plastic Clip for Wire Shelf	Black	4
AKPC	1/2" Post Clamp	Standard	1

Other accessories, customizations and finishes available with minimum order.

LABEL HOLDERS

SIMPLE, CONVENIENT, STREAMLINED



Standard Colours



Angle-Vu™ Adjustable Label Holder

PRODUCT HIGHLIGHTS:

- **Adjustable:** Tilts upward or downward for easy label visibility on high or low shelves.
- **Ergonomic:** Eliminates the need to bend or climb to read or scan labels.
- **Secure:** Snaps firmly onto most wire shelving systems.
- **5S Ready:** Ideal for 1:1 labelling in Lean and 5S environments.
- **Protected Labels:** Clear window shields included card stock from dust and damage.



29306



High

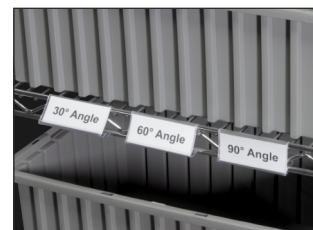

Low

29306 on wire shelving

Flat Label Holder

PRODUCT HIGHLIGHTS:

- **Low-Profile:** Mounts flush to the face of most wire shelving units.
- **5S Compatible:** Ideal for precise 1:1 labelling in Lean and 5S systems.
- **Protected Labels:** Clear window keeps included card stock clean and legible.
- **Easy Installation:** Snaps on quickly for a secure, no-fuss fit.



29308



29308 on wire shelving

Card Stock Systems Ltd.

Shelf Label Holders			Outside Dimensions (In.)		Other Specifications	
Model Number	Description	Colours	Width	Height	Cards Per Pack	Package Quantity
29306	Angle Shelf Label Holder	Standard	3	1-1/4	48	25
29308	Flat Shelf Label Holder	Standard	3	1-1/4	48	25

Card Stock Holders

Card stock with protective plastic holder.

Card Stock Holders			Outside Dimensions (In.)		Other Specifications	
Model Number	Compatibility	Colours	Width	Height	Cards Per Pack	Package Quantity
29300	All 4" Shelf Bins**	Standard	3	13/16	72	25
29301	30210, 30220, 30224 Bins; All 6"H Shelf Bins	Standard	3	1	60	25
29302	30230, 30234, 30235, 30239, 30240, 30250, 30255, 30348, 30358 Bins	Standard	4	1-3/4	36	25

The clear holders for the 29300 - 29302 fit in our card slot holder. **Excluding 30110 (29300 can be cut to length) 1-15/16.



29300 on shelf bin

Extended Label Holder

Creates large label area on shelf bins.



40410



AW40445

Extended Label Holders			Outside Dimensions (In.)		Other Specifications	
Model Number	Compatibility	Colours	Width	Height	Angle	Package Quantity
40410*	4"H Shelf Bins*, All 6"H Shelf Bins	Black	4	2-3/8	10 Degree	24
AW40445*	4"H Shelf Bins*, All 6"H Shelf Bins	Black	4	2-3/8	45 Degree	24



40410 on shelf bin

*Fits all 4"H shelf bins except 30110.

VERSATILE PLATFORM DECK TRUCKS

HEAVY-DUTY PLATFORM TRUCK



Standard Colours
BK

Versa Deck – Strong, Stable & Built to Haul

Versa Deck platform carts are engineered for high-capacity transport and rugged utility—perfect for warehouses, distribution centers, and manufacturing floors.

FEATURES:

- 1 **Non-Skid Deck:** Molded structural foam deck resists rust, rot, chipping, and cleans easily.
- 2 **Jam Bolts:** Secure handles in place on every model for added stability.
- 3 **Tie-Down Slots:** Four built-in slots keep cargo secure during movement.
- 4 **Steel Reinforcements:** Add strength and increase weight capacity.
- 5 **Removable Handles:** Powder-coated for durability and designed for space-saving storage and shipment.



R90182A1411

PRODUCT HIGHLIGHTS:

- **Durable:** HDPE structural foam deck paired with steel reinforcement holds up under heavy use.
- **Capacity:** Rated to carry loads of up to 2,000 lbs.

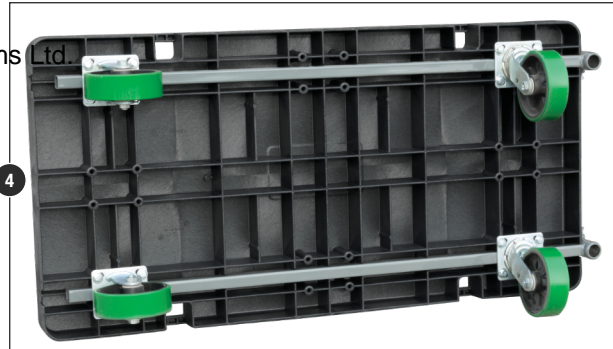

Under-deck steel reinforcements and bolt-on casters provide durability and a weight capacity of up to 2,000 lbs.

Handlebar Style

Open Swayback

Crossbar Swayback

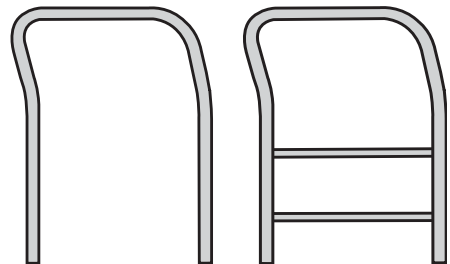

Caster Style

Pro-Tech Caster



Four molded-in tie-down slots for securing items during transport.



Steel outside deck handle pockets are welded to under deck reinforcements. Reinforced nut and bolt, standard on all models, hold handles in place.

Versatile Platform Deck Trucks				Outside Dimensions (In.)			Other Specifications		
Model Number	Colours	Handle Type	Caster Type	Length	Width	Height	Weight (Lbs.)	Capacity (Lbs.)	Caster Size (In.)
R90182A1411	Standard	Open	Pro-Tech Polyurethane	48	24	12-1/4	75.00	2000	6
R90182A1412	Standard	Crossbar	Pro-Tech Polyurethane	48	24	12-1/4	77.00	2000	6
R90282A1011	Standard	Open	Pro-Tech Polyurethane	60	30	12-1/4	88.00	2000	6
R90282A1012	Standard	Crossbar	Pro-Tech Polyurethane	60	30	12-1/4	91.00	2000	6

Ships in carton unassembled.

INDUSTRIAL EQUIPMENT

HEAVY-DUTY, RELIABLE CONSTRUCTION



Standard Colours



Dollies – Mobile Support for Container Handling

Designed for reliable transport of hand-held containers, these dollies offer rugged construction, smooth maneuverability, and size-specific compatibility.

FEATURES:

- 1 Plastic Dolly:** Features a one-piece deck with a 1” lip to secure loads. Made from high-impact polyethylene that resists rot, mildew, and splintering.
- 2 Steel Dolly:** All-welded 13-gauge steel or 1-1/2” × 1-1/2” × 1/8” angle steel for maximum strength. Powder-coated surface resists corrosion and wear.
- 3 Casters:** Equipped with four 3” swivel casters for smooth movement.

PRODUCT HIGHLIGHTS:

- **Functional:** Support and move loaded containers safely and efficiently.
- **Durable:** Plastic and steel options stand up to heavy use and environments.
- **Maintainable:** Easy-to-clean surfaces keep dollies working longer.



RU843HR1420



DY282305M5



DOLLY2818

Dollies		Outside Dimensions (In.)			Other Specifications		
Model Number	Colours	Length	Width	Height	Weight (Lbs.)	Capacity (Lbs.)	Material
DY282305M5	Blue	28	23	5-3/8	11	500	Plastic
RU843HR1420	Standard	19-7/8	14-1/4	5-1/2	9	900	Steel
DOLLY2818	Black	28-1/2	18-1/2	6-1/2	13	650	Plastic

Other sizes and styles available upon request (minimum orders apply).

Standard Colours



Industrial Step Stands – Stable, Tough & Easy to Handle

Step up with confidence using Industrial Step Stands—built for safety, durability, and easy handling in any environment.

FEATURES:

- 1 Wide, Non-Skid Step Surface:** Ensures solid footing with rubber feet for maximum stability.
- 2 Rotomoulded LDPE:** Chemical and UV resistant for indoor and outdoor use.
- 3 Moulded-In Handles:** Make transport and positioning quick and easy.

PRODUCT HIGHLIGHTS:

- **Durable:** Rugged design resists wear, weather, and chemicals.
- **Stable:** Wide base and grip surface provide sure footing.
- **Versatile:** Ideal for docks, garages, horse mounting, mechanic shops, etc.

Step Stands		Outside Dimensions (In.)			Other Specifications	
Model Number	Colours	Length	Width	Height	Weight (Lbs.)	Capacity (Lbs.)
SS1	Standard	28	20	13	10	500
SS2	Standard	36	28	20	20	500

Other colours available upon request (minimum orders apply).

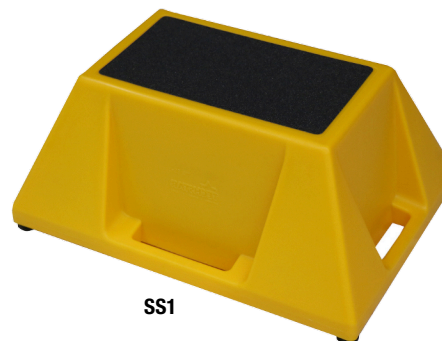

SS1

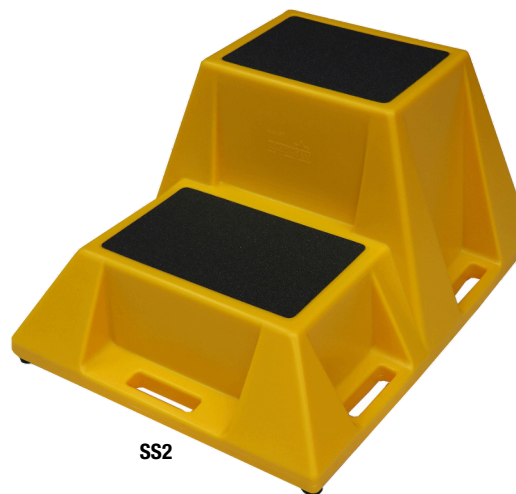

SS2

PROCART UTILITY CART

VERSATILE CONVERTIBLE UTILITY CART



Standard Colours



ProCart Utility Carts – Versatile, Convertible & Ready to Roll

ProCart Utility Carts are built to flex with your workflow—combining secure transport, ergonomic design, and durable construction to meet the needs of busy workspaces. Whether you're managing tools, parts, or supplies, these carts adapt quickly for storage, mobility, or assembly tasks.

FEATURES:

- 1 **Convertible:** Hinged side gates flip up or down to shift from box-top to flat-top cart.
- 2 **Built-In Storage:** Molded compartments keep essentials within reach (cup holder included on 30936 large cart).
- 3 **Comfortable Grip:** Full-width handle offers complete control during transport.
- 4 **Smooth Maneuverability:** Toe-touch locking rear swivel wheels and 5" polyurethane-on-polyolefin wheels (1.75" x 3" bolt pattern).
- 5 **Heavy-Duty:** I-beam post allows easier loading of oversized items onto the lower shelf.
- 6 **Optional Add-On:** Rail systems (sold separately) accommodate Hanging and Stacking Bins or 19-Series Steel Cabinets.

PRODUCT HIGHLIGHTS:

Caster-Rack Systems Ltd.

- **Versatile:** Converts quickly for open or contained transport; ideal for assembly lines, warehouses, and more.
- **Durable:** High-density structural foam resists dents, rust, and wear—no painting required.
- **Capacity:** Carries up to 400 lbs. total; 200 lbs. per shelf.
- **Assembly:** Light setup required for fast deployment.
- **Variety:** Available in 2 size options to suit different workstations.



Hinged side gates on both shelves flip up or down to convert the ProCart to a flat-top or box-top cart



I-Beam post makes it easy to load and unload boxes on the lower shelf

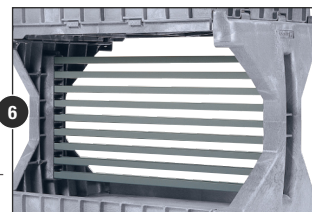

Optional rails utilize extra space with hanging and stacking bins, bin cabinets, and tilt view storage bins.

ProCart Rail Kits		Other Specifications	
Model Number	Description	Weight (Lbs.)	Capacity (Lbs.)
30900	9-Rail System for 30930	20.70	10
30906	9-Rail System for 30936	22.50	15



ProCart Mobile Carts		Outside Dimensions (In.)			Other Specifications		
Model Number	Colours	Length	Width	Height	Weight (Lbs.)	Capacity (Lbs.)	Carton Quantity
30930	Standard	41-1/2	19	34-3/4	51.00	400	1
30936	Standard	45-5/8	24	34-3/4	62.00	400	1

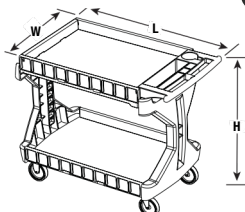

Easy assembly - Requires Phillips screwdriver and rubber mallet.

Customize ProCart: Use this chart when ordering one size Hanging and Stacking Bins and 19-Series Cabinets for your ProCart												
Model Number	30210	30220	30224	30230	30234	30235	30239	30240	30250	30255	30320	19-Series Cabinets*
30930	70	70	42	30	-	12	12	-	-	-	-	2
30936	80	80	48	36	36	18	16	16	8	12	6	4

*Requires 98400 suspension straps for hanging.

UTILITY BOX CARTS

DURABLE, VERSATILE, EFFORTLESS MOBILITY

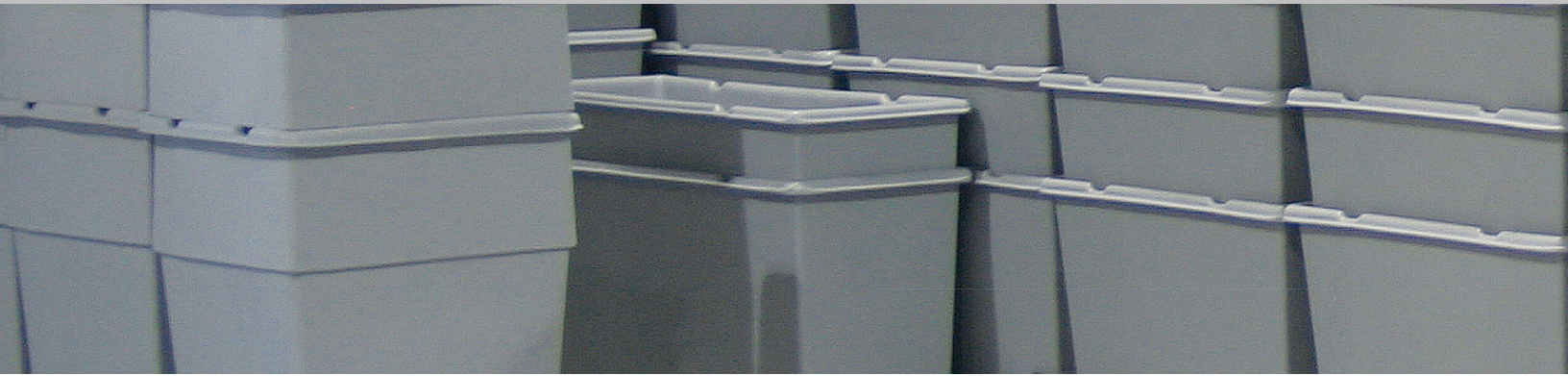

Heavy-Duty Utility Carts, Seamless Strength, Smooth Mobility

Built for reliability and long-term use, these rugged Utility Carts are the ideal solution for transporting heavy materials in industrial environments. With thick, rotomoulded bodies and reinforced bases, they offer unparalleled durability, easy handling, and safe, ergonomic design.

FEATURES:

- 1 Durable Wall Construction:** Seamless rotomoulded body withstands heavy impacts without cracking, fading, or corroding.
- 2 Reinforced Base:** Includes a treated plywood base for extra structural integrity. Optional plastic base for food and wet applications available.
- 3 Easy Maneuvering:** Mini and Standard-Duty carts are equipped with 2" thread guard casters, and Heavy-Duty carts are equipped with 4" casters for smooth rolling and effortless handling.
- 4 Ergonomic Design:** Built for safe loading and unloading to reduce physical strain.
- 5 Caster Pattern:** All swivel, corner caster, and diamond caster options available on select models.

PRODUCT HIGHLIGHTS:

- Multiple Options:** Carts available in mini, standard-duty, and heavy-duty styles to suit your needs.
- Smart Accessories:**
 - *Spring platforms* (optional) elevate materials for easier access and reduce bending.
 - *Lids* (optional) available for **models 125 & 145 style** to protect contents and minimize dust.
- Colour Flexibility:** Stocked in grey; other colours available upon request.
- Easy Access:** Reduce stress and strain on the lower back with easy access cut-out models.



Diamond Caster

Corner Caster



Platform lowers with weight and raises automatically when weight is removed

RELATED PRODUCTS:

Create the perfect storage system - mix and match your selection of utility carts with the following products.



Bulk Linen Carts



Platform Deck Trucks



Portable Organizers



Tilt Dumping Trucks

UTILITY BOX CARTS

DURABLE, VERSATILE, EFFORTLESS MOBILITY



Standard Colours



ACCESSORIES:

Optional Cart Accessories	
Model Number	Description
125L	Lid for 125EC, 125A, 125B Carts
145L	Lid for 145A, 145B, 155B Carts
125SPRING	Spring platform for 125 Series Carts
145SPRING	Spring platform for 135, 145, 150, and 155 Series Carts



Spring Platform
Available on select models

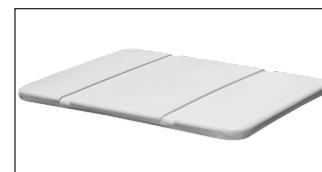

Lid
Available on select models

Other colours, sizes and customizations available upon request (minimum orders apply).

Utility Box Carts			Outside Dimensions (In.)			Inside Dimensions (In.)			Other Specifications					
Model Number	Style	Colours	Length	Width	Height	Length	Width	Height	Caster Size (In.)	Caster Pattern	Bushels	Volume (Cu. Ft.)	Weight (Lbs.)	Capacity (Lbs.)
105A	Mini	Standard	33	19	28	30	16	24	3	Corner	5	6	25	200
110A	Mini	Standard	35	25	25	31	21	21	3	Corner	7	8	30	300
115A	Mini	Standard	48	19	28	45	16	24	3	Corner	8	9	40	300
125EC	Regular-Duty	Black	39	27	29	35	23	25	3	Corner	10	12	30	200
125A	Regular-Duty	Standard	39	27	30	35	23	25	3	Diamond	10	12	40	400
135A	Regular-Duty	Standard	41	29	31	37	25	26	3	Diamond	12	15	45	400
145A	Regular-Duty	Standard	43	31	33	38	26	28	3	Diamond	14	16	50	400
125B	Heavy-Duty	Standard	39	27	31	35	23	25	4	Both	10	12	50	800
135B	Heavy-Duty	Standard	41	29	32	37	25	26	4	Both	12	15	55	800
145B	Heavy-Duty	Standard	43	31	34	38	26	28	4	Both	14	16	60	800
155B	Heavy-Duty	Standard	43	31	36	38	26	30	4	Both	16	19	65	800

Other colours, sizes and customizations available upon request (minimum orders apply). Specify caster pattern upon order.



Easy Access Box Carts			Outside Dimensions (In.)			Inside Dimensions (In.)			Other Specifications					
Model Number	Style	Colours	Length	Width	Height	Length	Width	Height	Caster Size (In.)	Caster Pattern	Bushels	Volume (Cu. Ft.)	Weight (Lbs.)	Capacity (Lbs.)
150B	Heavy-Duty	Standard	43	31	36	38	26	29	4	Both	16	19	52	800
165B	Heavy-Duty	Standard	46	31	39	41	27	32	5	Both	18	21	75	900
175B	Heavy-Duty	Standard	46	31	49	41	27	42	5	Both	21	24	85	900
185B	Heavy-Duty	Standard	63	31	39	58	27	32	5	Both	21	24	100	900

Other colours, sizes and customizations available upon request (minimum orders apply). Specify caster pattern upon order.

NEXT GENERATION UTILITY CARTS

BUILT TO ROLL, BUILT TO LAST



Standard Colours



Next Generation Utility Carts – Built to Roll, Built to Last

Experience the next generation of utility carts, engineered for superior strength, smooth mobility, and long-lasting performance. With a rugged design that combines durability, maneuverability, and ergonomic handling, this cart is ready to take on the toughest tasks in any environment.

FEATURES:

- 1 **Double-Wall Lip:** Reinforced box-style lip adds exceptional impact resistance and structural strength.
- 2 **Smooth Mobility:** Equipped with two heavy-duty front casters and two large rear poly-core wheels for effortless rollability and control.
- 3 **Seamless Durability:** One-piece molded body resists cracking, chipping, fading, rusting, denting, splintering, and corrosion.
- 4 **Reinforced Undercarriage:** Steel frame provides added support and stability under heavy loads.
- 5 **Ergonomic Handling:** Molded-in handles offer a secure, comfortable grip for easy maneuvering.

Caster-Rack Systems Ltd.



PRODUCT HIGHLIGHTS:

- **Durable:** Built for demanding environments - ideal for industrial, commercial, and institutional use.
- **Ergonomic:** Designed for comfort and control, even when fully loaded.



Next Generation Utility Cart		Outside Dimensions (In.)			Other Specifications		
Model Number	Colours	Length	Width	Height	Weight (Lbs.)	Capacity (Lbs.)	Caster Pattern
730B	Standard	48	31	34-1/2	80	1000	Corner
750B	Standard	60	31-1/2	35-1/2	100	1000	Corner
770B	Standard	72	35-1/2	40	130	1500	Corner

Other colours, sizes and customizations available upon request (minimum orders apply).

BULK HANDLING LINEN CARTS

ERGONOMIC MEETS HEAVY-DUTY



Standard Colours

BL

Bulk Handling Linen Cart – Ergonomic Meets Heavy-Duty

Designed to handle larger loads without compromising maneuverability or user comfort, the Bulk Handling Linen Cart offers smart design and serious durability for demanding environments. Perfect for healthcare, hospitality, and industrial laundry operations, this cart combines reinforced structure with smooth mobility.

FEATURES:

- 1 **Heavy-Duty:** Equipped with a rugged molded plastic base and heavy ribbing for maximum strength and impact resistance.
- 2 **Smooth Transport:** Four 6" non-marking neoprene casters (2 rigid, 2 swivel) arranged in a corner pattern provide stable and agile movement.
- 3 **Ergonomic Access:** Sidewall opening allows for easy loading and unloading, minimizing physical strain.
- 4 **High Capacity:** 1700B and 1800B are designed to handle up to 1,000 lbs. of linen or bulk material.

PRODUCT HIGHLIGHTS:

- **Ergonomic:** Built with easy-access features for comfortable operation and reduced bending.
- **Durable:** Reinforced body resists damage from heavy use and repeated handling.
- **Mobile:** Neoprene casters glide smoothly without marking floors, perfect for both carpet and hard surfaces.
- **High-Capacity:** Suitable for heavy loads without compromising stability or control.

Convertible Linen Truck

The 1750B offers dual functionality with drop-down shelves that form a secure door. Built for durability and smooth transport, it features heavy-duty ribbing, non-marking neoprene casters, and snag-free design.

CUSTOMIZABLE OPTIONS:

- Open or closed top (closed top shown).
- Choice of cart colour.
- Choice of shelf colour.



1800B



1700B



1750B

Bulk Handling Linen Carts		Outside Dimensions (In.)			Inside Dimensions (In.)			Other Specifications						
Model Number	Colours	Length	Width	Height	Length	Width	Height	Caster Size (In.)	Caster Pattern	Bushels	Volume (Cu. Ft.)	Weight (Lbs.)	Capacity (Lbs.)	Caster Pattern
1700B	Standard	48	28	55	47	27	46	6	Corner	30	37	120	1000	Corner
1800B	Standard	48	28	66	47	27	57	6	Corner	37	46	145	1000	Corner
1750B	Standard	48	28	73-1/2	-	-	-	6	Corner	37	46	200	1500	Corner

Other colours, sizes and customizations available upon request (minimum orders apply).

JUMBO UTILITY CARTS

HIGH CAPACITY, SMOOTH HANDLING BULK TRANSPORT



Standard Colours



Jumbo Utility Cart – High-Capacity, Smooth-Handling Bulk Transport

Built for big jobs, the Jumbo Utility Cart is our largest model, designed to carry heavy loads without sacrificing maneuverability. Perfect for industrial, textile, or facility-wide handling, this cart blends serious capacity with ergonomic ease.

FEATURES:

- 1 Massive Capacity:** Supports up to 1,500 lbs. for heavy-duty use.
- 2 Caster Configuration:** Comes with 2 rigid and 2 swivel threadguard casters mounted on a recessed plywood undercarriage for balance and smooth motion.
- 3 Surprisingly Agile:** Despite its size, rolls easily for efficient transport.
- 4 Cut-Out Options:** Choose from 1-tier cut-out, 2-tier cut-out, 1-side cut-out, or 2-side cut-outs for customized accessibility. (1-tier / 1-side option shown).



PRODUCT HIGHLIGHTS:

Caster-Rack Systems Ltd.

- Heavy-Duty:** Built to handle bulky, weighty loads with structural stability.
- Functional:** Customize access based on workflow with multiple cut-out configurations.
- Durable:** Reinforced undercarriage ensures long-term use in demanding environments.
- Easy to Handle:** Smooth casters and thoughtful design make maneuvering easy; even when fully loaded.



Corner Caster

Diamond Caster

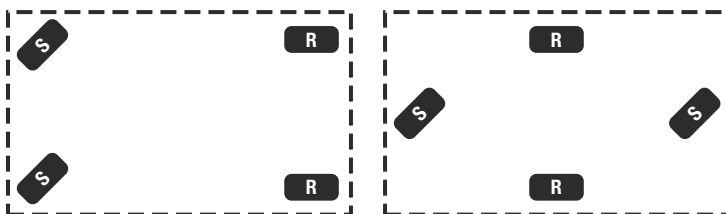

Jumbo Utility Carts		Outside Dimensions (In.)			Inside Dimensions (In.)			Other Specifications					
Model Number	Colours	Length	Width	Height	Length	Width	Height	Caster Size (In.)	Caster Pattern	Bushels	Volume (Cu. Ft.)	Weight (Lbs.)	Capacity (Lbs.)
840B	Standard	62	44	38	60	40	28	6	Both	30	38	180	1200
850A	Standard	65	45	52	62	42	42	5	Both	48	60	170	900
850B	Standard	65	45	54	62	42	42	6	Both	48	60	200	1500

Other colours, sizes and customizations available upon request (minimum orders apply).

TILT TRUCKS

BULK HANDLING AND WASTE TRANSPORT SYSTEMS



Standard Colours



Tilt Trucks – Heavy-Duty Hauling with Durable Design

Engineered for industrial toughness and efficient transport, Tilt Trucks are built to take on the heaviest loads with ease. Designed with reinforced features and ergonomic handling, they provide superior durability and maneuverability across both heavy-duty and regular-duty models.

FEATURES:

Regular-Duty Tilt Trucks – Economical Strength:

- 1 **FDA-Approved Polyethylene:** Lightweight yet durable—ideal for cost-conscious applications.
- 2 **Nestable Design:** Minimizes shipping costs and storage footprint.
- 3 **Optional Accessories:** Hinged lids available for models 420LT & 441LT.

Heavy-Duty Tilt Trucks – Rugged & Reliable:

- 1 **Double-Wall Lip:** Increases impact resistance and structural longevity.
- 2 **Molded Collar:** “C” Series reinforced boxed design eliminates the need for a costly steel frame.
- 3 **Ergonomic Handling:** Molded-in handles deliver a secure, comfortable grip.
- 4 **Optional Accessories:** Hinged lids available for models 420C & 441C; replacement casters upon request.

PRODUCT HIGHLIGHTS:

- **Seamless Body:** Won't crack, chip, fade, rust, dent, splinter, or corrode; no painting required.
- **Heavy-Duty Wheel Base:** Combines durability and maneuverability for challenging environments.

Note: Some tilt trucks are oversized. Please measure all doorways and access points to ensure smooth transport.

ACCESSORIES:



Lid

Available on select models



420EC



420LT



441LT



420C



441C

Heavy-Duty Tilt Trucks			Outside Dimensions (In.)			Other Specifications			
Model Number	Style	Colours	Length	Width	Height	Caster Size (In.)	Volume (Cu. Yd.)	Weight (Lbs.)	Capacity (Lbs.)
420EC	Regular-Duty	Black	55	28	38	10 (x2) + 4 (x1)	5/8	50	300
420LT	Regular-Duty	Standard	55	28	38	10 (x2) + 4 (x1)	5/8	70	400
441LT	Regular-Duty	Standard	63	35	40	10 (x2) + 3 (x2)	1.1	85	500
420C	Heavy-Duty	Standard	58	29	38	10 (x2) + 4 (x1)	5/8	85	1000
441C	Heavy-Duty	Standard	68	36	42	12 (x2) + 4 (x2)	1.1	100	1200

Other colours, sizes and customizations available upon request (minimum orders apply).



TILT TRUCKS

BULK HANDLING AND WASTE TRANSPORT SYSTEMS

Standard Colours



77710F

Heavy-Duty Tilt Trucks

Built for rugged performance and effortless transport, these tilt trucks are designed to handle bulky, heavyweight loads with ease. Whether manually maneuvered or forklift-assisted, they offer durability, efficiency, and convenience in demanding environments.

FEATURES:

- 1 **Space-Saving Nesting:** Fully assembled units nest for compact shipping and storage.
- 2 **Smooth Mobility:** Wheel base and heavy-duty casters ensure easy maneuverability, even under heavy loads.
- 3 **Forklift Compatibility:** Optional forklift channels allow fully loaded trucks to be moved by lift trucks, saving time and labor.
- 4 **Reinforced Frame:** Powder-coated tubular steel frame extends under top rim for added strength.
- 5 **Optimized for Dumpers:** Fully welded, reinforced frame and lift handles optimized for with tilt cart dumper.

PRODUCT HIGHLIGHTS:

- **Variety:** Available in standard or forkliftable models (forkliftable models include an “F” in the model number).
- **Seamless Body:** One-piece molded tub resists rust, dents, and chips; easy to clean.
- **Durable:** Heavy-duty construction supports automatic dumper applications.
- **Industrial Grade:** Ideal for industrial, commercial, and waste-handling operations.

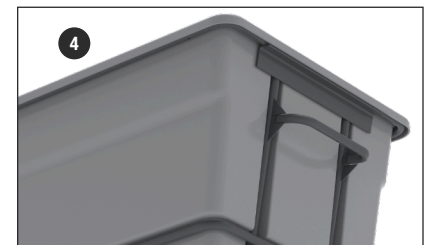

Heavy-Duty Tilt Trucks			Outside Dimensions (In.)			Wheels		Other Specifications				
Model Number	Model Number with Fork Channels	Colours	Length	Width	Height	Wheel Diameter	Wheel Type*	Volume (Gal.)	Volume (Cu. Yd.)	Volume (Cu. Ft.)	Weight (Lbs.)	Capacity (Lbs.)
77405	77405F	Standard	59	29	38	12	SP	100	1/2	13.5	94	600
77410	77410F	Standard	68	33	42	12	SP	200	1	27	137	600
77505	77505F	Standard	59	29	38	10	MR	100	1/2	13.5	115	1000
77510	77510F	Standard	68	33	42	10	MR	200	1	27	150	1000
77610	77610F	Standard	68	33	42	12	MR	200	1	27	165	2000
77710	77710F	Standard	85	38	50	12	MR	300	1-1/2	40.5	137	2000
77810	77810F	Standard	86	48	50	12	MR	400	2	54	252	2000

*SP = Semi-Pneumatic MR = Mold-On Rubber. Forklift channel option eliminates nestability of units.

RECYCLING AND WASTE CONTAINERS

DURABLE, SECURE, RELIABLE



Standard Colours



Bullseye™ Containers – Durable, Secure, and Ready to Sort

Bullseye™ containers are designed for long-term performance in demanding environments. With rugged rotomoulded construction and thoughtful features, they're ideal for efficient and organized recycling in schools, offices, and public spaces.

PRODUCT HIGHLIGHTS:

- **Long-Lasting:** Rotomoulded body ensures exceptional durability for years of reliable use.
- **Lockable Lid:** Provides added security and prevents tampering or accidental spills
- **Removable Liners:** Includes 550 liners (18 imperial gallons each), compatible with standard 30" x 38" garbage bags.
- **Bilingual Labeling:** Each container ships with sheets of English and French labels for clear waste stream identification.



TS565



TS575

Bullseye Recycling Containers		Outside Dimensions (In.)			Other Specifications		
Model Number	Colours	Length	Width	Height	Weight (Lbs.)	Volume (L)	Lid Style
565	Standard	36	19	38	50	82 x 2	Mixed
575	Standard	54	19	38	90	82 x 3	Mixed

Other colours and customizations available upon request (minimum orders apply).

Standard Colours



075618



075611

Desk & Curbside Recycling Containers – Ergonomic, Durable, and Space-Saving

Designed for everyday recycling needs, these containers are ideal for use in offices, schools, and public spaces. Whether placed under desks, counters, or used curbside, they offer a clean, efficient solution for collecting paper, bottles, and cans.

PRODUCT HIGHLIGHTS:

- **Multi-Use:** Under-table and curbside containers are suitable for cans, bottles, and paper recycling.
- **Ergonomic:** Designed with comfortable handles for easy lifting and transport.
- **Durable:** Made from tough materials that won't rust, corrode, or splinter.
- **Compact:** Nestable when empty to save valuable storage space.
- **Stackable:** Model 075611 features cross-stacking capability for added versatility.

Desk and Curbside Recycling Containers		Outside Dimensions (In.)			Inside Dimensions (In.)			Other Specifications	
Model Number	Colours	Length	Width	Height	Length	Width	Height	Weight (Lbs.)	Capacity (Lbs.)
075611	Standard	20-7/8	15-3/4	12	16-3/4	11-7/8	11-1/2	3.80	40
075618	Standard	24-3/8	17-1/5	13-3/8	20-3/4	13-7/8	12-7/8	4.60	50

Other colours and customizations available upon request (minimum orders apply).



SOS STORAGE BINS

RUGGED, WEATHER RESISTANT, RELIABLE

Standard Colours



SOS™ Storage Bin – Rugged, Secure, All-Purpose Containers

From rural roads to pool decks to truck beds, the SOS™ Storage Bin delivers reliable protection, high-impact durability, and lockable security for tools, chemicals, or seasonal materials.

FEATURES:

- 1 **Lockable Security:** Molded-in hasp allows padlocking (not included) to safeguard contents in any setting.
- 2 **Weather-Resistant Construction:** Rotomoulded with a double-walled lid for durability and protection from harsh elements.
- 3 **Versatile Storage:** Ideal for storing salt, sand, garbage, tools, safety gear, and poolside chemicals.
- 4 **Maneuverable:** Fork channels come in all sizes, except the SA500 and SOS5.5.
- 5 **Nesting:** Nestable design when empty to save on storage space and shipping.



PRODUCT HIGHLIGHTS:

- **Functional:** Suitable for rural, residential, industrial, and vehicle-based applications.
- **Durable:** Tough rotomolded build with UV inhibitors resists impact and outdoor exposure over time.
- **Long-Lasting:** Designed to deliver years of use without compromising structural integrity.
- **Variety:** Stocked in Yellow and Grey; other colours available upon request.

Caster-Rack Systems Ltd.



SC00P



SA500



SOS5.5

SOS11

SOS18

SOS36

SOS Storage Bins		Outside Dimensions (In.)			Other Specifications		
Model Number	Colours	Length	Width	Height	Volume (Cu. Ft.)	Weight (Lbs.)	Capacity (Lbs.)
SA500	Yellow	30	25	24	5.5	21	500
SOS5.5	Standard	30	24	23	5.5	30	500
SOS11	Standard	42	29	30	11	50	1000
SOS18	Standard	48	33	34	18.5	65	1750
SOS36	Standard	72	36	36	36	88	3500

Other colours and customizations available upon request (minimum orders apply).

PRODUCT INDEX

MATERIAL HANDLING STORAGE SOLUTIONS

105A	68	750B	69	13017	17	30158	8
110A	68	770B	69	13018	17	30161	53
115A	68	840B	71	19228	49	30164	8
125A	68	850A	71	19320	49	30170	8
125B	68	850B	71	19416	49	30174	8
125EC	68	1700B	70	19715	49	30178	8
125L	68	1750B	70	19909	49	30184	8
125SPRING	68	1800B	70	20228	50	30210	4
135A	68	3501-BDLP-95	51	20320	50	30210ESD	5
135B	68	3502-BDLP-95	51	20416	50	30220	4
145A	68	3602-BLP-95	51	20715	50	30220ESD	5
145B	68	4800	45	20909	50	30224	4
145L	68	4800LID	45	29300	8,63	30230	4
145SPRING	68	4900	45	29301	4,5,10,63	30230ESD	5
150B	68	4900LID	45	29302	4,5,63	30234	4
155B	68	05705	47	29306	63	30235	4
165B	68	05805	47	29308	63	30235ESD	5
175B	68	05905	47	30008	54,55	30237	4
185B	68	06118	47	30014	10	30239	4
305A1	6	06702	18	30016	54,55	30240	4
305A2	6	06703	18	30040	10	30240ESD	5
305A3	6	06704	18	30048	10	30250	4
305A4	6	06705	18	30080	10	30255	4
305A5	6	06706	18	30084	10	30260	4
305A6	6	007640	24	30088	10	30265	4
305B1	6	007641	24	30090	10	30270	4
305B2	6	007644	24	30094	10	30280	16
405A1	6	007670	29	30098	10	30281	16
405A3	6	007671	29	30101	8	30282	16
405A5	6	007678	29	30102	8	30283	16
405B1	6	09185	46	30110	8	30284	16
420C	72	09514	46	30118	53	30286	16
420EC	72	09912	46	30120	8	30287	16
420LT	72	10116	48	30124	8	30288	16
441C	72	10124	48	30128	8	30289	16
441LT	72	10126	48	30130	8	30290	16
565	74	10144	48	30138	8	30292	16
575	74	10164	48	30148	54,55	30293	16
730B	69	13014	17	30150	8	30312	13

Caster-Rack Systems Ltd.

PRODUCT INDEX

MATERIAL HANDLING STORAGE SOLUTIONS

30318	13	33164	36	37682	35	40717	48
30320	4	33165	36	37686	35	41105	36
30348	12	33166	36	37688	35	41164	36
30358	12	33168	36	39085	32	41166	36
30424	55	33220	36	39120	32	41168	36
30618	53	33222	36	39120CLEAR	32	41220	36
30632	53	33223	36	39170	32	41223	36
30635	53	33224	36	40020	10	41224	36
30636	53	33226	36	40030	10	41226	36
30651	53	33228	36	40040	10	41228	36
30653	53	35010	21,36	40120	8,11	41230	4,5
30655	53	35180	21	40130	8,11	41250	4
30658	53	35181	21	40150	8	41270	4
30661	53	35185	21	40170	8	41284	16
30661DOLLY	53	35190	21	40210	4,5	41286	16
30676	53	35191	21	40220	4,5	41287	16
30716	13	35195	21	40224	4	41288	16
30718	13	35200	21	40230	4,5	41289	16
30776	13	35201	21	40234	4	41410	14
30778	13	35225	21	40239	4	41440	14
30796	13	35230	21	40245	4,5	41460	14
30812	54,55	35231	21	40260	4	41480	14
30900	66	35240	21	40265	4	42105	36
30906	66	35241	21	40270	4	42162	36
30930	66	35300	21	40280	16	42164	36
30936	66	35301	21	40281	16	42165	36
31112	14	36442	11	40282	16	42166	36
31118	14	36448	11	40286	16	42168	36
31142	14	36462	11	40287	16	42220	36
31148	14	36468	11	40290	16	42222	36
31162	14	37208	35	40292	16	42223	36
31168	14	37278	35	40321	4	42224	36
31182	14	37288	35	40348	12	42226	36
31188	14	37608	35	40358	12	42228	36
33011	36	37612	35	40410	8,10,63	66486CLDBL	32
33023	36	37616	35	40442	11	66486FILEB	32
33061	36	37672	35	40445	8,10	66497CLDGN	32
33105	36	37676	35	40462	11	075611	29,74
33162	36	37678	35	40716	48	075618	29,74

Caster-Rack Systems Ltd.

PRODUCT INDEX

MATERIAL HANDLING STORAGE SOLUTIONS

77405	73 AK54-18724A	60 AK74-18604	59 AK1836SHELF	61
77405F	73 AK54-24364	59 AK74-18604A	60 AK1848SHELF	61
77410	73 AK54-24364A	60 AK74-18724	59 AK1860SHELF	61
77410F	73 AK54-24484	59 AK74-18724A	60 AK1872SHELF	61
77505	73 AK54-24484A	60 AK74-24364	59 AK2424SHELF	61
77505F	73 AK54-24604	59 AK74-24364A	60 AK2436SHELF	61
77510	73 AK54-24604A	60 AK74-24484	59 AK2448SHELF	61
77510F	73 AK54-24724	59 AK74-24484A	60 AK2460SHELF	61
77610	73 AK54-24724A	60 AK74-24604	59 AK2472SHELF	61
77610F	73 AK54POST	61 AK74-24604A	60 AK421212DIVIDER	19
77710	73 AK63-12364	59 AK74-24724	59 AK42121203	19
77710F	73 AK63-12364A	60 AK74-24724A	60 AKFP	62
77810	73 AK63-12484	59 AK74POST	61 AKPC	62
77810F	73 AK63-12484A	60 AK86-12364	59 AKPH18	62
96352A	47 AK63-18364	59 AK86-12364A	60 AKPH24	62
96352B	47 AK63-18364A	60 AK86-12484	59 AKSHOOK	62
98325	50 AK63-18484	59 AK86-12484A	60 APRBENCH	56
98400	55 AK63-18484A	60 AK86-18364	59 APRD	56
98600	53 AK63-18604	59 AK86-18364A	60 APRD18	56
98636	53 AK63-18604A	60 AK86-18484	59 APRD18MOBILE	56
AC211509	31 AK63-18724	59 AK86-18484A	60 APRDMOBILE	56
AC211512	31 AK63-18724A	60 AK86-18604	59 APRS	56
AG191405	26 AK63-24364	59 AK86-18604A	60 APRS18	56
AG201604	26 AK63-24364A	60 AK86-18724	59 AR151413	31
AG201605	26 AK63-24484	59 AK86-18724A	60 AR151415	31
AK5CASTER	62 AK63-24484A	60 AK86-24364	59 AR201207	31
AK34POST	61 AK63-24604	59 AK86-24364A	60 AR211517	31
AK39POST	61 AK63-24604A	60 AK86-24484	59 AR242012	31
AK54-12364	59 AK63-24724	59 AK86-24484A	60 AR271709	31
AK54-12364A	60 AK63-24724A	60 AK86-24604	59 AR271712	31
AK54-12484	59 AK63POST	61 AK86-24604A	60 AS282115	31
AK54-12484A	60 AK74-12364	59 AK86-24724	59 AS342015	31
AK54-18364	59 AK74-12364A	60 AK86-24724A	60 AW30550	12
AK54-18364A	60 AK74-12484	59 AK86POST	61 AW30600	12
AK54-18484	59 AK74-12484A	60 AK96POST	61 AW30605	12
AK54-18484A	60 AK74-18364	59 AK1224SHELF	61 AW40445	63
AK54-18604	59 AK74-18364A	60 AK1236SHELF	61 AWCLIP	62
AK54-18604A	60 AK74-18484	59 AK1248SHELF	61 AWDONUT	62
AK54-18724	59 AK74-18484A	60 AK1824SHELF	61 AWRAIL	54

Caster-Rack Systems Ltd.

PRODUCT INDEX

MATERIAL HANDLING STORAGE SOLUTIONS

BA23200422	27	CF57453200	41	PP1070D	37	SW242211F1	34
BA26220322	27	CF57454100	41	QRB166	19	SW242214F1	34
BA26220522	27	CF57456500	41	QRB206	19	SW15120602	34
BA26220622	27	CF57457400	41	QRB246	19	SW24150602	34
BA26220722	27	CT29260922	27	R90182A1411	64	SW32150802	34
BA29260684	27	DC201207	31	R90182A1412	64	SW48150802	34
BC32302520	39	DC211509	31	R90282A1011	64	TC48400200	44
BC32303420	39	DC211512	31	R90282A1012	64	TC48450300	44
BC48403420	39	DC211517	31	RU843HR1420	65	TH48400200	44
BC48403920	39	DC242012	31	SA500	75	TH48450200	44
BC48452520	39	DC271712	31	SL15120100	34	TL42290400	44
BC48453420	39	DC282015	31	SL24150100	34	TL48440300	44
BC48454220	39	DL21150902	28	SL24160200	23	TS32300200	44
BC48455020	39	DL24201202	28	SN20161200	24	TS48450300	44
BF42292800	44	DL24201202M	28	SN21141200	24	TV57480200	44
BF48442900	44	DOLLY2818	65	SN24160800	23	TV64480200	44
BG48404602	40	DR21150100	28	SN24160822	23	TV70480200	44
BH48402520	40	DR24200100	28	SN24161200	23	TZ48400200	42
BH48403420	40	DR24200102M	28	SN24161222	23		
BH48452520	40	DSH-124-95	51	SN24161600	23		
BH48453420	40	DSH-184-95	51	SN24161622	23		
BL27230623	27	DY282305M5	65	SOS5.5	75		
BN32302520	39	ECOUS5CD6R	37	SOS11	75		
BN32303420	39	ECOUS5OD6R	37	SOS18	75		
BN48452520	39	FDC-SH-3618-95	51	SOS36	75		
BN48453420	39	FDC-SH-4818-95	51	SS1	65		
BN48454120	39	JL25160968	25	SS2	65		
BN48454420	39	LJ25160200	25	SW120705F1	34		
BN48455120	39	LVDMOBILE	53	SW151205F1	34		
BS57483420	40	NP484006CD	37	SW151207F1	34		
BS64483420	40	NP24161195	28	SW151209F1	34		
BS70483420	40	NRUS5CD	37	SW241504A2	34		
BT28220522	27	NRUS5OD	37	SW241505F1	34		
BT28220722	27	NS920	24	SW241507F1	34		
BZ484447V0	43	PFV6411	26	SW241509F1	34		
BZ48404610	42	PFV6418	26	SW241511F1	34		
C18525	28	PFV6422	26	SW241514F1	34		
C18541	28	PFV6426	26	SW242207F1	34		
C18702	24	PP107CD	37	SW242209F1	34		

Caster-Rack Systems Ltd.

THE AK-WEST ADVANTAGE

At Ak-West, our extensive line of material handling solutions are designed to boost efficiency, reduce costs, and streamline operations across virtually every industry. From storage and organization to transport and protection, our products help you:

- Speed up assembly processes
- Maintain accurate inventory
- Maximize storage space
- Protect valuable parts and components

When you choose Ak-West, you're choosing quality, reliability, and a partner committed to your success.

EXCEPTIONAL CUSTOMER SERVICE

Our knowledgeable customer service team is here to support you every step of the way. Whether you need product guidance or help finding the fastest way to get what you need, we're just a call or click away.

READY TO SHIP WHEN YOU ARE

With fully stocked inventories in Calgary, Alberta and Mississauga, Ontario, and multiple manufacturing locations, we're equipped to deliver what you need—fast. Many of our products are available off-the-shelf and ready to ship!

Message from the President

At Ak-West, our mission is to deliver innovative, high-quality storage and material handling solutions. We back every product with professional support and dependable service because your success is our priority.

If you're ever less than completely satisfied with an Ak-West product, or if you have ideas on how we can serve you better, we want to hear from you!



Caster-Rack
Systems Ltd.

AK **AK-WEST INC.**
Leaders in Reusable Containers and Material Handling Solutions



Caster-Rack
Systems Ltd.

Distributed in Atlantic Canada by

Caster-Rack Systems Ltd.
Halifax, Nova Scotia

Ph: 902-468-1880

Toll Free 1-800-565-1880

www.caster-rack.com

Email: sales@caster-rack.com